



GoVac

USER'S GUIDE

Model 3301 Series



3 Safety Instructions

4 Product View

4-5 Assembly

5-6 Operations / Maintenance

7 Troubleshooting

7 Replacement Parts

8 Warranty



Thanks for buying a GoVac

We're glad you purchased a GoVac. Everything we know about floor care and cleaning went into the design and construction of this handy appliance.

Your GoVac is well made, and we back it with a limited one-year warranty. We also stand behind it with a knowledgeable, dedicated Consumer Services Department, so, should you ever have a problem, you'll receive fast, considerate assistance.

My great-grandfather invented the floor sweeper in 1876. Today, BISSELL is a global leader in the design, manufacture, and service of high quality homecare products like your GoVac.

Thanks again, from all of us at BISSELL.

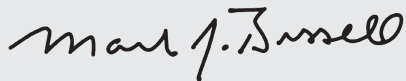

Mark J. Bissell
President and Chief Executive Officer

IMPORTANT SAFETY INSTRUCTIONS

Read all instructions before using the GoVac.

 **WARNING:** When using an electrical appliance, basic precautions should be observed, including the following:

- Store indoors.
- Do not expose to rain.
- Do not immerse or use on wet surfaces.
- Do not handle with wet hands.
- Do not use if it has been dropped, damaged, left outdoors or dropped into water - take it to a Service Center.
- Do not damage the charging cord. Never carry or pull by the cord, use cord as a handle, close door on cord, or pull cord around sharp edges or corners. Keep cord away from heated surfaces.
- Do not use an extension cord. DC adapter should plug directly into electrical outlet.
- Do not put any object into appliance openings, or restrict air flow.
- Do not use with any opening blocked.
- Do not use without filter in place.
- Do not pick up hot, burning or smoking objects such as cigarettes, matches or hot ashes.
- Do not pick up flammable or combustible materials (lighter fluid, gasoline, kerosene, etc.) or use in the presence of explosive liquids or vapor.
- Do not use appliance in an enclosed space filled with vapors given off by oil base paint, paint thinner, some moth proofing substances, flammable dust, or other explosive or toxic vapors.
- Do not pick up toxic material (chlorine bleach, ammonia, drain cleaner, gasoline, etc.).

- Do not use for any purpose other than described in this User's Guide.
- Use only manufacturer's recommended attachments - use of attachments not provided or sold by BISSELL may cause fire, electric shock or injury.
- Use only the DC adapter supplied by BISSELL to recharge your GoVac.
- Use charger unit only in standard electrical outlet (120v - 60hz).
- Keep openings free of dust, lint, hair, etc.
- Disconnect GoVac from DC adapter before maintenance or cleaning.
- Be extra careful when cleaning stairs.

This portable hand vacuum contains rechargeable nickel cadmium batteries. Do not incinerate batteries or they will explode when exposed to high temperatures.

Battery cell leaks can occur under extreme conditions. If battery cell liquid comes in contact with the skin:

- Wash immediately with soap and water. Then . . .
- Neutralize with a mild acid such as vinegar or lemon juice.

If battery cell liquid gets into the eyes:

- Flush immediately with clean water for a minimum of 10 minutes.
- Seek medical attention.

WARNING: The Power Cord on this product contains lead, a chemical known to the State of California to cause birth defects or other reproductive harm.

WASH HANDS AFTER HANDLING.

SAVE THESE INSTRUCTIONS.

This model is for household use only.

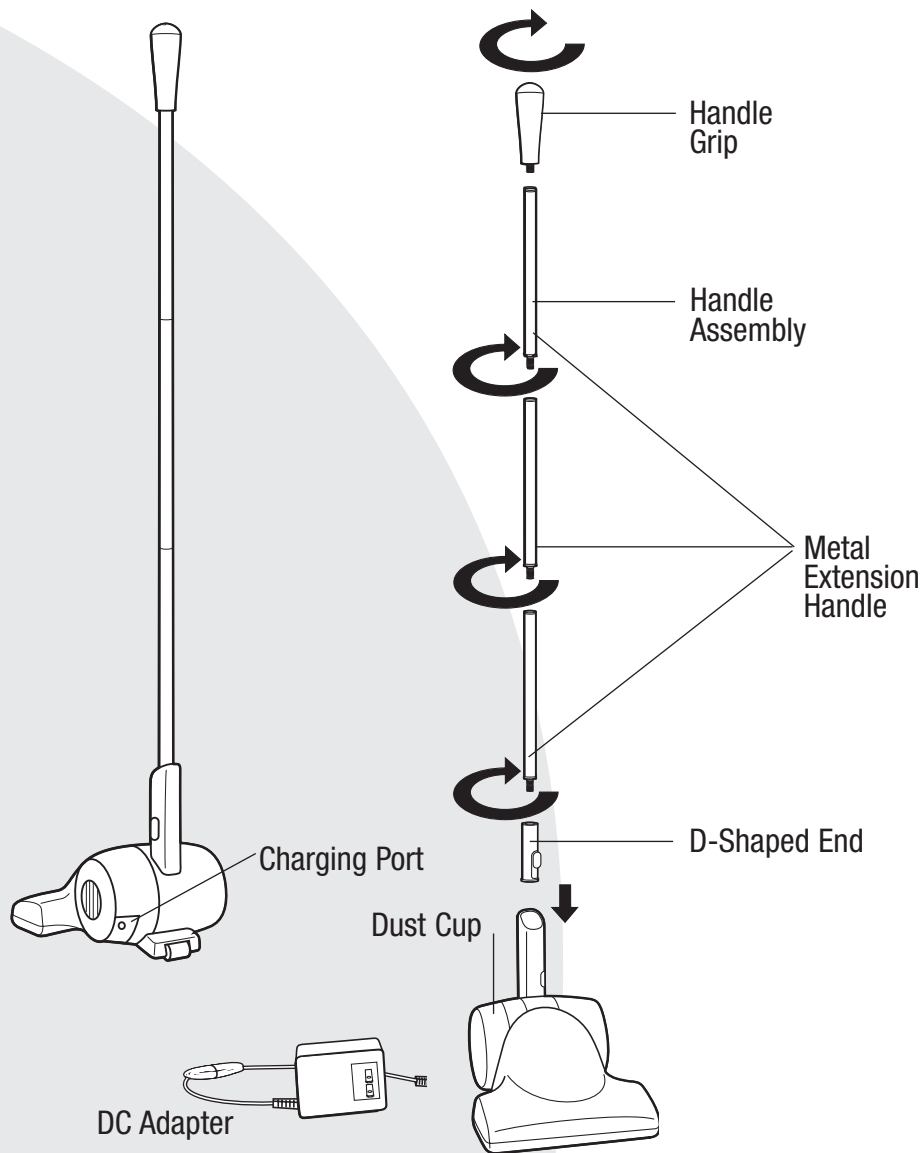

How To Use This Guide

This User's Guide has been designed to help you get the most satisfaction from the rechargeable GoVac. Enclosed you'll find assembly instructions, tips for all cleaning tasks, safety precautions, plus maintenance and troubleshooting instructions. Please read this Guide thoroughly before using your GoVac. Pay particular attention to the parts diagram, assembly instructions and part names. Following the Guide will greatly enhance your ability to get the most performance from your GoVac for many years.



WARNING:

Electric/electronic appliances should not be subjected to extreme temperatures or high humidity. Do not store the GoVac in bathing areas or close to stoves, furnaces or radiators.

How to Assemble the GoVac

The GoVac requires very little assembly. Remove it from the box and check it against the illustration to familiarize yourself with the components listed. The exploded view drawing with part names will also be helpful if you should need to order a part at a later time.

Quick and Easy Assembly

1. Assemble the Handle by screwing together two (2) pieces of the Metal Extension Handle. To lengthen, use all three (3) pieces of the Metal Extension Handle. Place the colored Handle Grip on top of the metal extension assembly and twist clockwise until secure. Screw the D-shaped End into the bottom of the Metal Extension Handle assembly.
2. Place bottom D-shaped End into the D-shaped opening at the top of the GoVac. Push firmly until the button at the bottom "clicks" into place in the opening.
3. The GoVac must be fully charged before using. To charge the unit, plug the DC Adapter into a standard electrical outlet (120v-60hz); plug the opposite end into the port on the Motor side of your GoVac. The GoVac is now charging.

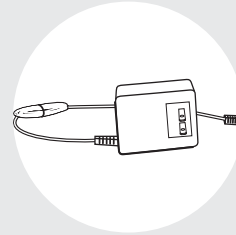

Charging Cord with DC Adapter Plug

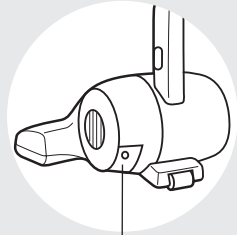

Plug into Port on the Motor side of the GoVac

Components

1. **Charging Cord with DC Adapter Plug** - DC Adapter plugs into standard electrical outlet (120v - 60hz); plug opposite end into port on Motor side of GoVac.
2. **Dust Cup** - Press and turn to securely lock.
3. **Washable Filter** - Fits inside Dust Cup.
4. **Metal Extension Handle** (five pieces).
5. **Rotating Brush.**
6. **Dust Blade.**

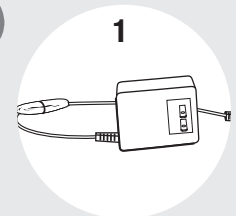

1

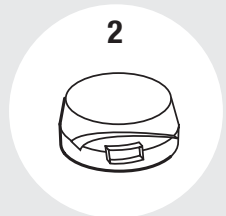

2

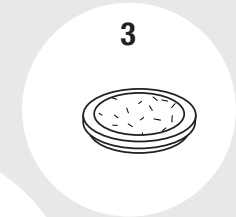

3

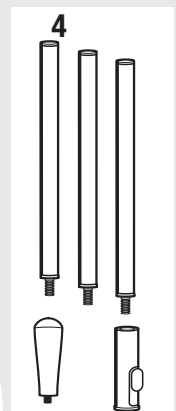

4

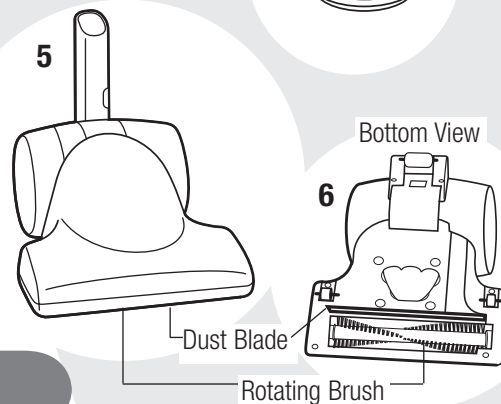

5

Bottom View

6

Dust Blade

Rotating Brush

Charging the Battery

1. When completely charged, the GoVac provides over 12 minutes of full cleaning power.
2. When charging for the first time, allow to charge uninterrupted for at least 24 hours. Thereafter, a 12 -16 hour charge will renew the GoVac battery.
3. Decreased operating time may indicate the battery has built up a charging resistance. To recharge, first completely exhaust the battery, recharge it, then exhaust it again before recharging a second time. This procedure may be required more than once.
4. When not charging, be sure to unplug the GoVac from the charger.

Charging the Battery – Continued

If your battery still fails to recharge or does not hold a charge of normal duration, call:

BISSELL Consumer Services

1-800-237-7691

Monday - Friday 8 a.m. — 10 p.m. ET

Saturday 9 a.m. — 8 p.m. ET

Or visit our website @ www.bissell.com

How To Use Your GoVac

The GoVac is a quick and easy way to clean your home.

- 1.** Tip back the Handle into typical use position and your GoVac turns on by itself. To turn GoVac off, return Handle to upright position.
- 2.** To clean small areas, detach the Handle by depressing the button where the bottom of the Handle slides into the GoVac and pull the entire Handle assembly out. Use the GoVac by holding the built-in hand grip.
- 3.** When done, replace the Handle (if detached) and store for the next use.

Maintenance

The key to maximum performance is emptying the Dust Cup frequently and cleaning the Filter. Emptying the Dust Cup after each use, and cleaning the Filter periodically, will help your GoVac operate at peak efficiency.

- 1.** Make sure that the GoVac is in the "OFF" position.
- 2.** With GoVac facing away from you, grasp Dust Cup in right hand and turn it toward you (toward the back of the GoVac).
- 3.** Carry the Dust Cup, with Filter in place, to a waste container. Remove Filter, empty debris, then replace Filter in Dust Cup.
- 4.** Replace Dust Cup by placing it in position and turning it away from you until it fits securely.
- 5.** Clean exterior surfaces with a soft cloth dampened with water only. Do not use a strong detergent or other cleaner - this may damage the finish. Always unplug the GoVac from the electrical outlet before cleaning the surface.
- 6.** After heavy usage, you may clean the Filter by gently rinsing it in a bowl of water and mild dish detergent. Rinse thoroughly under running water and make certain it is completely dry before replacing it. You may also purchase replacement Filters.

Use only BISSELL Filters in the GoVac. If the Filter becomes damaged or becomes too dirty to wash, you may purchase new filters by calling BISSELL Consumer Services.

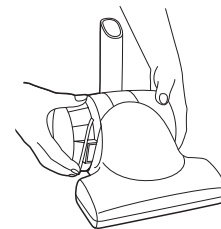
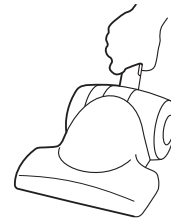
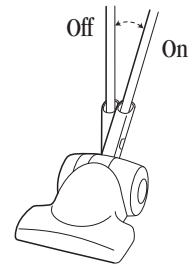

WARNING:

Never operate the GoVac without the Filter in place. Doing so may damage the motor and void the warranty.

See the following instructions to dispose of the batteries after they have exceeded the battery life.



WARNING: This product contains a nickel-cadmium (Ni-Cd) rechargeable battery pack. According to Federal and State regulations, removal and proper disposal of Ni-Cd batteries is required. For removal of the battery pack in your GoVac, see instructions below:

1. **IMPORTANT:** Unplug charger.
2. Remove Handle and Dust Cup.
3. Remove (10) Phillips head screws on the bottom cover as shown in picture.
4. Separate top and bottom cover.
5. Remove wire connectors from the battery pack.
6. Keep Battery Pack together - **DO NOT** separate individual batteries.
For specific disposal instructions of batteries, please contact:
RBRC (Rechargeable Battery Recycling Corporation) 1-800-822-8837 or
visit the website: www.rbrc.com
7. Discard remainder of product.

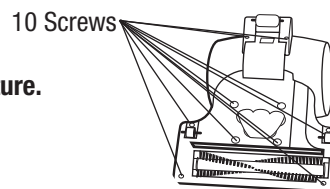

Troubleshooting

Reduced Suction/No Suction.

Possible Causes

- 1 Dust Cup is full

Remedies

- 1 Empty debris from Dust Cup and clean Filter.

Not Powered/Underpowered.

Possible Causes

- 1 GoVac not charged thoroughly

Remedies

- 1 Make sure it has been properly plugged into an outlet for the recommended amount of time.
- 2 See Charging the Battery on page 5.

If suggested solutions for this or any function of the GoVac do not correct the problem, call BISSELL Consumer Services.

Replacement Parts

Item	Part No.	Part Name
1	203-3540	Filter (2 Pack)
2	204-1100	DC Adapter
3	203-4480	Metal Extension Handle (4 Sections)
4	204-1101	Handle Grip
5	203-0660	Dust Cup

To order replacement parts using your VISA, MasterCard, Discover or American Express, call:

BISSELL Consumer Services

1-800-237-7691

Monday - Friday 8 a.m. — 10 p.m. ET

Saturday 9 a.m. — 8 p.m. ET

Or visit our website @ www.bissell.com

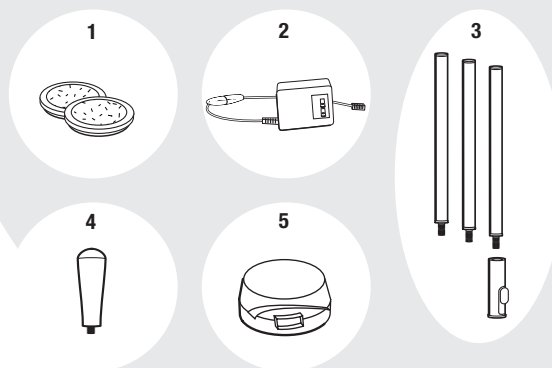



Warranty

This warranty gives you specific legal rights, and you may also have other rights which may vary from state to state. If you need additional instruction regarding this warranty or have questions regarding what it may cover, please contact BISSELL Consumer Services by e-mail, telephone, or regular mail as described below.

Limited One Year Warranty

Subject to the *EXCEPTIONS AND EXCLUSIONS identified below, upon receipt of the product, BISSELL Homecare, Inc. will repair or replace (with new or remanufactured components or products), at BISSELL's option, free of charge from the date of purchase by the original purchaser, for one year any defective or malfunctioning part.

See information below on "If your BISSELL product should require service".

This warranty applies to product used for personal, and not commercial or rental service. This warranty does not apply to fans or routine maintenance components such as filters, belts, or brushes. Damage or malfunction caused by negligence, abuse, or use not in accordance with the User's Guide is not covered.

If your BISSELL product should require service:

Call BISSELL Consumer Services at the number listed below or visit the BISSELL website - www.bissell.com to locate a BISSELL Authorized Service Center in your area.

-- The machine should be taken to a service center with a photocopy of your proof of purchase. (Your dated sales receipt is your warranty - do not send original.)

If you need information about repairs or replacement parts, or if you have questions about your warranty, contact BISSELL Consumer Services.

Website or E-mail:

www.bissell.com

Use the "Customer Services" tab.

Or Call:

BISSELL Consumer Services

1-800-237-7691

Monday - Friday 8 a.m. - 10 p.m. ET

Saturday 9 a.m. - 8 p.m. ET

Or Write:

BISSELL Homecare, Inc.

PO Box 3606

Grand Rapids MI 49501

ATTN: Consumer Services

BISSELL HOMECARE, INC. IS NOT LIABLE FOR INCIDENTAL OR CONSEQUENTIAL DAMAGES OF ANY NATURE ASSOCIATED WITH THE USE OF THIS PRODUCT. BISSELL'S LIABILITY WILL NOT EXCEED THE PURCHASE PRICE OF THE PRODUCT.

Some states do not allow the exclusion or limitation of incidental or consequential damages, so the above limitation or exclusion may not apply to you.

*EXCEPTIONS AND EXCLUSIONS FROM THE TERMS OF THE LIMITED WARRANTY

THIS WARRANTY IS EXCLUSIVE AND IN LIEU OF ANY OTHER WARRANTIES EITHER ORAL OR WRITTEN. ANY IMPLIED WARRANTIES WHICH MAY ARISE BY OPERATION OF LAW, INCLUDING THE IMPLIED WARRANTIES OF MERCHANTABILITY AND FITNESS FOR A PARTICULAR PURPOSE, ARE LIMITED TO THE ONE YEAR DURATION FROM THE DATE OF PURCHASE AS DESCRIBED ABOVE.

Some states do not allow limitations on how long an implied warranty lasts, so the above limitation may not apply to you.



©2004 BISSELL Homecare, Inc.
Grand Rapids, Michigan
All rights reserved. Printed in China
Part Number 603-5814
Rev 11/04

Visit our website at:
www.bissell.com