

**Bissell®**

**WE MEAN CLEAN**

## Little Green®

### USER'S GUIDE

1720-1725 SERIES



3 Safety Instructions

4 Product view

5-6 Product features

7-9 Operations

9 Storage

10 Troubleshooting

11 Consumer Services

11 Replacement Parts

12 Warranty



*Thanks for buying a BISSELL Little Green Portable Deep Cleaner*

We're glad you purchased a BISSELL Little Green® Portable Deep Cleaner. Everything we know about floor care went into the design and construction of this handy, high-tech home cleaning system.

Your Little Green is well made, and we back it with a full one-year warranty. We also stand behind it with a knowledgeable, dedicated Consumer Services department, so, should you ever have a problem, you'll receive fast, considerate assistance.

My great-grandfather invented the floor sweeper in 1876. Today, BISSELL is a global leader in the design, manufacture, and service of high quality homecare products like your Little Green.

Thanks again, from all of us at BISSELL.

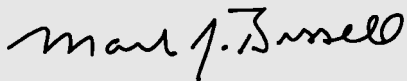

Mark J. Bissell  
President and Chief Executive Officer

# IMPORTANT SAFETY INSTRUCTIONS

**⚠️ WARNING:** When using an electrical appliance, basic precautions should be observed, including the following:

Read all instructions before using your LITTLE GREEN®. Use only on surfaces moistened by cleaning process. Always connect to a properly grounded outlet, see grounding instructions. Unplug from outlet when not in use and before conducting maintenance or troubleshooting. To reduce the risk of fire, electric shock or injury:

- Do not expose to rain, store indoors.
- Do not leave LITTLE GREEN® when it is plugged in.
- Do not service LITTLE GREEN® when it is plugged in.
- Do not use with damaged cord or plug.
- Do not use LITTLE GREEN® if it has been dropped, damaged, left outdoors or dropped into water, have it repaired at an Authorized Service Center.
- Do not pull or carry by cord, use cord as a handle, close door on cord, pull cord around sharp corners or edges, run appliance over cord, or expose cord to heated surfaces.
- Do not carry the appliance while in use.
- Do not handle LITTLE GREEN® plug or appliance with wet hands.
- Do not put any object into appliance openings, use with blocked opening, or restrict air flow.
- Do not expose hair, loose clothing, fingers or body parts to openings or moving parts.
- Do not pick up hot or burning objects.
- Do not pick up flammable or combustible materials (lighter fluid, gasoline, kerosene, etc.) or use in the presence of explosive liquids or vapor.
- Do not use appliance in an enclosed space filled with vapors given off by oil base paint, paint thinner, some moth proofing substances, flammable dust, or other explosive or toxic vapors.
- Do not pick up toxic material (chlorine bleach, ammonia, drain cleaner, gasoline, etc.).
- Do not modify the 3-prong grounded plug.
- Do not allow to be used as a toy.
- Do not use for any purpose other than described in this User's Guide.
- Unplug before attaching the TurboBrush™.
- Never spray at people or animals.

- Use only manufacturer's recommended attachments.
- Use only cleaning products formulated by BISSELL for use in this appliance.
- Keep openings free of dust, lint, hair, etc.
- Keep appliance on a level surface.
- Turn off all controls before unplugging.
- Unplug by grasping the plug, not the cord. Do not unplug by pulling on cord.
- Be extra careful when cleaning stairs.
- Close attention is necessary when used by or near children.

## SAVE THESE INSTRUCTIONS.

## GROUNDING INSTRUCTIONS.

This appliance must be connected to a grounded wiring system. If it should malfunction or break down, grounding provides a safe path of least resistance for electrical current, reducing the risk of electrical shock. The cord for this appliance has an equipment-grounding conductor and a grounding plug. It must only be plugged into an outlet that is properly installed and grounded in accordance with all local codes and ordinances.

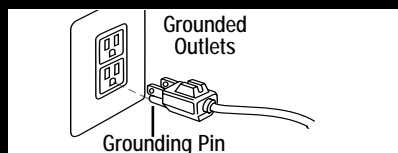

**⚠️ WARNING:** Improper connection of the equipment-grounding conductor can result in a risk of electrical shock. Check with a qualified electrician or service person if you aren't sure if the outlet is properly grounded. **DO NOT MODIFY THE PLUG.** If it will not fit the outlet, have a proper outlet installed by a qualified electrician. This appliance is designed for use on a nominal 120-volt circuit, and has a grounding attachment plug that looks like the plug in the drawing above. Make certain that the appliance is connected to an outlet having the same configuration as the plug. No plug adapter should be used with this appliance.

This model is for household use only.



### WARNING:

Do not use this product while on any type of a ladder. Do not place the product in a place where it will be stepped on or kicked while in use. Do not place the product on an elevated surface where it may be pulled off the surface while in use.



### WARNING:

Do not use an extension cord with this product. The use of an extension cord may result in a severe electrical shock, particularly if the extension cord does not have an electrical rating higher than that of the product, if the extension cord does not have a three prong grounding plug and connector and if the extension cord is not plugged into a circuit box with a ground fault circuit interrupter. Safety precautions such as keeping all connections off the ground and dry will not eliminate the danger.

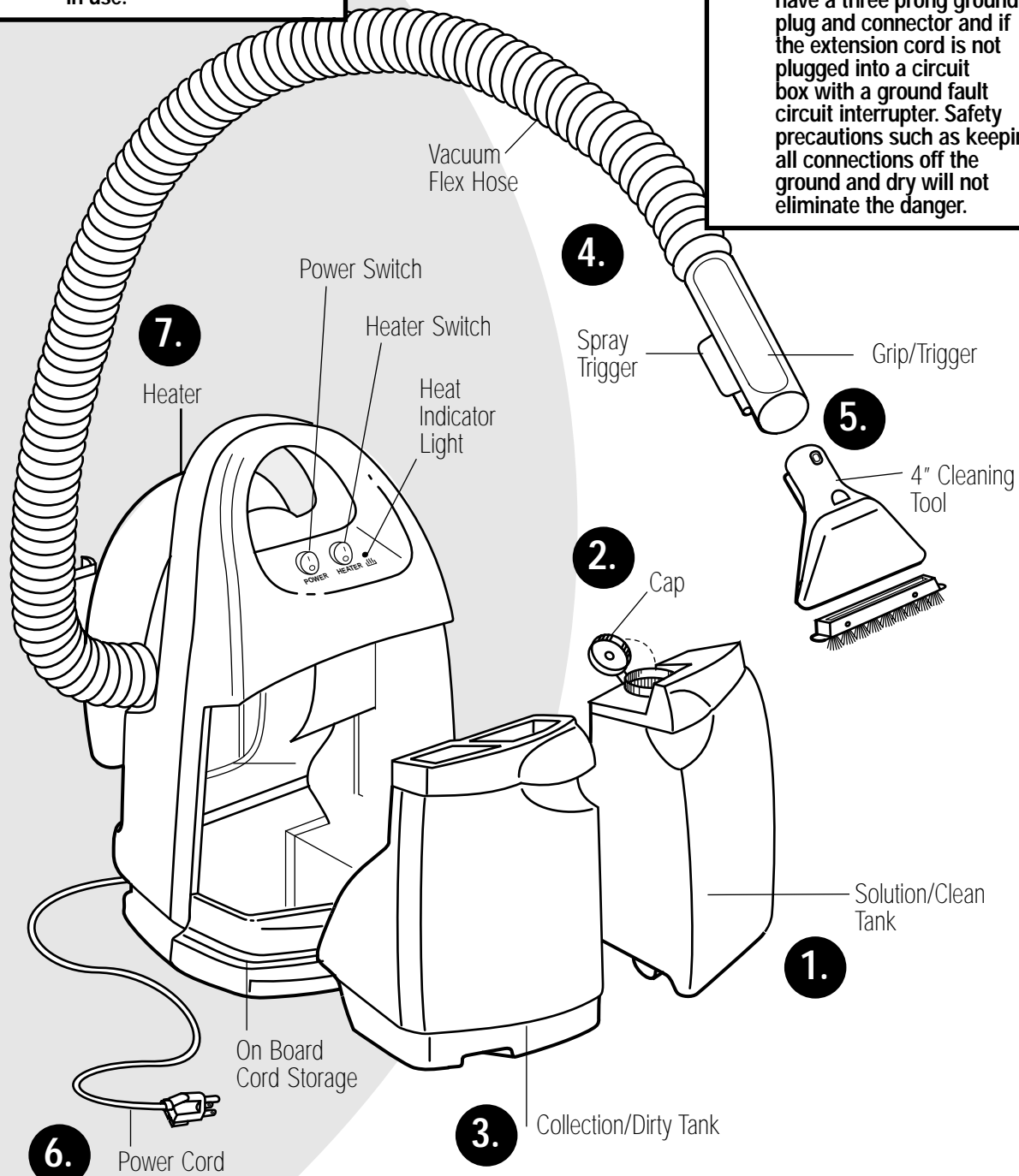

## How to use this guide

This User's Guide has been designed to help you get the utmost satisfaction from your BISSELL Little Green Portable Deep Cleaner. You'll find assembly and operating instructions, safety precautions, as well as maintenance and troubleshooting instructions. Please read this Guide thoroughly before assembling your cleaner.

Pay particular attention to the product diagram, assembly instructions, and part names. Locate and organize all parts before assembly. Familiarize yourself with the parts and where they go. Following this User's Guide will greatly enhance your ability to get the most performance from your BISSELL Little Green for many years.



### **WARNING:**

**Do Not plug in your deep cleaner until you have completely assembled it per the following instructions and are familiar with all instructions and operating procedures.**

## Product Features

Refer to Assembly Diagram on page 4

### **Solution Tank**

The Solution Tank is the translucent tank at your right as you face the Little Green. Remove the Tank by grasping the indented handle and pulling it toward you, then tilting out.

### **To Fill the Solution Tank**

Open the Solution Tank by pulling up on the round cap. Add BISSELL Little Green Formula to the FORMULA fill line (8-oz.) on Solution Tank.

**NOTE: Your Little Green is shipped with an 8 oz. starter bottle of formula.**

Fill the Solution Tank with hot (NOT boiling) tap water to the WATER fill line.

Replace the cap before placing the Solution Tank back into the unit.

Replace the Solution Tank by pacing it bottom first into the cavity, then tilting it, pressing gently at top until it snaps closed.

### **Collection Tank**

The Collection Tank is the translucent tank at your left as you face the Little Green. It is removed and replaced on the unit just like the Solution Tank. Empty the Collection Tank after each use, when dirty water reaches the indicated maximum fill line, or as instructed in this User's Guide.

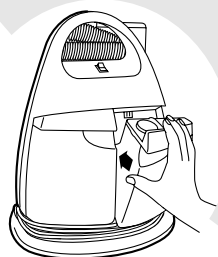
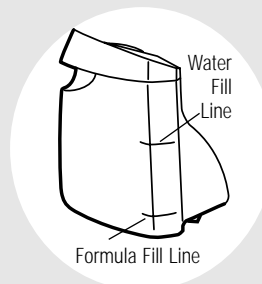
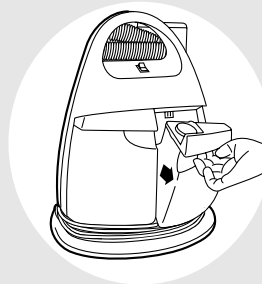

## Product Features Continued

### Vacuum Flex Hose with Grip/Trigger Unit

Store in the on-board hose storage on the back of the Little Green. Cleaning tools attach to the Grip/Trigger unit.

### Power Cord

The cord, with a three-prong grounded plug, stores in the On Board Cord Storage at the bottom of the Little Green.

**Note: Unwrap Power Cord completely before operating unit.**

### Built-in-heater

#### **Not included with all models**

With the Little Green ProHeat, you have the ability to turn on, or leave off, the built-in heater, based on your cleaning needs.

The Little Green ProHeats' built-in heater will raise the water temperature for improved cleaning performance. To use Little Greens' built-in heater, first turn the Power Switch ON and then turn the Heater Switch ON. Within 30 seconds, the Heat Indicator Light will illuminate, indicating the heater has reached the correct temperature.

Begin using by depressing the Spray Trigger. Wait 5-10 seconds for non-heated water and solution mixture to travel through the Flex Hose. After 5-10 seconds, the heated water and solution mixture is ready to be applied to carpet or upholstery.

See Page 8 for cleaning instructions.

**⚠ WARNING:**  
Use only BISSELL Little Green formula in your cleaner. Use of cleaning formulas which contain lemon or pine oil may damage this appliance and void warranty. Chemical spot cleaners or solvent-based soil removers should not be used. These products may react with the plastic materials used in your cleaner, causing cracking or pitting.

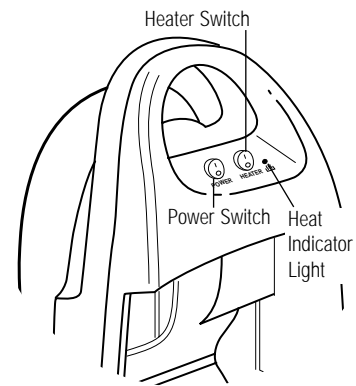

## Specialized Cleaning Tools

Depending on which model you purchased, your Little Green may be equipped with one or more of these tools:

1. 4" wide Cleaning Tool (included with all models)-For cleaning carpet, upholstery and spot cleaning
2. Spraying Crevice Tool-For cleaning in tight areas
3. 6" wide Cleaning Tool-For larger areas
4. TurboBrush Cleaning Tool-Rotating brush for extra cleaning action for small areas, upholstery and stairs

To order optional tools not originally included with your Little Green see "Part Numbers and Descriptions," page 9

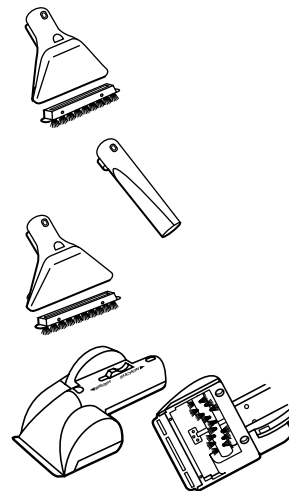

## How To Deep Clean Carpet or Upholstery

### Getting Ready

1. Remove Vacuum Flex Hose completely from On Board Hose Storage.
  2. Attach 4" Tool, TurboBrush\* or Crevice Tool\* to Grip Trigger Unit by pressing Tool onto Grip/Trigger Unit firmly, until button snaps into hole. Make certain Tool is securely attached.
  3. Unwrap Power Cord completely from On Board Cord Storage and plug into 1230 Volt, 60 Hz grounded outlet as described in Important Safety Instructions, page 3.
  4. Turn Power switch to ON Position.
- Note: If your Little Green has a built-in heater, refer to instructions on page 7.**
5. Press and hold Spray Trigger on Grip/Trigger unit. Spray will start in a few seconds.
  6. Raise the Tool slightly to check for spray. If spray does not start, press firmly on the front of the Solution Tank while depressing Spray Trigger.

**\*Optional on some Little Green models. To order optional parts not originally included in your Little Green model, call BISSELL Consumer Services at the telephone number listed on page 9.**

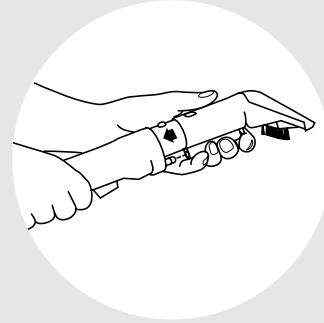

**⚠ WARNING:**  
Be sure to unplug the cord before attaching the Turbobrush.

### Pre-treating

1. Pre-treat stained or highly soiled areas: Hold the flex hose with tool attached above carpet or upholstery, and pull trigger to spray cleaning solution.
2. Wait 3-5 minutes before cleaning.

## Deep Cleaning

1. Place the tool directly on soiled surface at arms length. Apply downward pressure on the tool and pull toward you, while pulling trigger to spray cleaning solution.

**Note: If using the TurboBrush, the switch should be in the "BRUSH" position. This activates the brush only.**

2. Repeat, keeping the tool firmly against the surface. Continue until no more dirt can be removed. **Do not overwet.**

**Note: If using the Turbobrush, move the switch to the "SUCTION" position. This activates the suction to remove the dirt and cleaning solution. Move the switch back to the "BRUSH" position for additional brushing action.**

Do not overwet.

3. Release spray trigger. Vacuum area until no more cleaning solution can be removed.

**Note: If using the Turbobrush, move the switch to the "SUCTION" position. This activates the suction to remove the dirt and cleaning solution.**

4. If the tool stops spraying, turn OFF Power Switch and check cleaning solution level. Refill if needed. Never run dry.

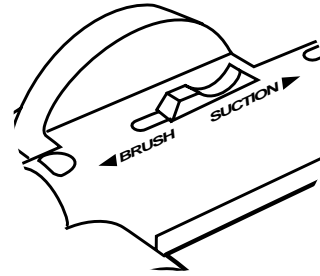

## Deep Cleaning Upholstery

1. Check the manufacturer's tag before cleaning. "W" or "WS" on the tag means you can use your Little Green. If tag is coded with an "S" (with diagonal strike-through), or says "Dry Clean Only," do not proceed.

2. If manufacturer's tag is missing or not coded, check with your furniture dealer.

3. If possible, check upholstery stuffing. Colored stuffing may bleed through fabric when wet.

### *Tip:*

Deep cleaning stairs and high traffic areas on a regular basis can prolong carpet life.

### *Tip:*

Check upholstery stuffing before cleaning. Colored stuffing may bleed through fabric when wet.



## When You're Done

1. Turn Power Switch to OFF position.
2. Unplug Power Cord from outlet.
3. Remove and rinse Solution Tank, then replace.  
**Note: If a significant amount of Little Green formula/water remains, you may leave it in the Solution Tank for your next cleaning task.**
4. Remove Collection Tank, fill with clean water, rinse thoroughly and discard, then replace.
5. Disconnect the tool from Grip/Trigger unit by pushing down on button lock and pulling straight off (Do NOT twist tools to remove them).
6. Once removed from the Vacuum/Flex Hose, the tools can be cleaned:  
4", 6", or Crevice tool-Rinse under clean running water. TurboBrush tool-Switch must be in "SUCTION" position. Rinse under clean running water.
7. Check Spray Nozzle for accumulated dirt or debris. If necessary, clean with soft bristle brush.

### Tip:

Before turning off Little Green, vacuum up clean water to thoroughly rinse the Vacuum Hose. Then, lift the tool and point upwards. This allows any water still in the Hose to flow into the Collection Tank.



### WARNING:

Keep face away from spray. Failure to do so may result in personal injury.

## Storage

1. Wipe all surfaces with a soft cloth.
2. Wrap Power Cord around Onboard Cord Storage at the bottom of Little Green.
3. Wrap Vacuum Flex Hose around Onboard Hose Storage and secure Grip/Trigger.
4. Store Cleaner in protected, dry area, at room temperature (40° to 110°F).

**Note: For Little Green TurboBrush Models, on-board storage for the TurboBrush Tool has been provided on the back of the unit. Attach the TurboBrush to the unit by pressing onto holder firmly until button snaps into hole.**

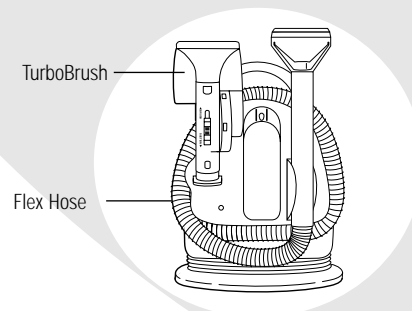
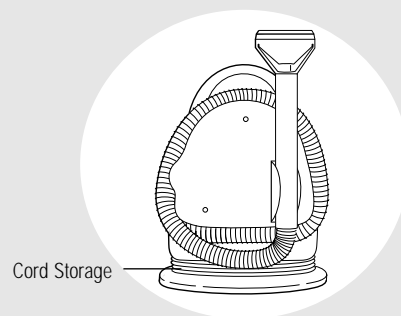



## WARNING:

To reduce the risk of injury from moving parts and/or electrical shock, turn Power Switch OFF and disconnect polarized plug from electrical outlet before performing troubleshooting checks.

### **Cleaner won't run.**

#### Possible Causes

Power Unit not plugged in  
Blown fuse/tripped breaker

#### Remedies

Check electrical plug  
Replace household fuse or Reset Breaker  
Call BISSELL Consumer Services

### **Reduced spray or no spray**

#### Possible Causes

Spray Nozzle clogged  
Solution Tank empty  
Solution Tank outlet clogged  
Pump needs priming

#### Remedies

Clean Spray Nozzle  
Check/Refill Tank  
Clean outlet at bottom of Solution Tank  
Push firmly on Solution Tank front while depressing Spray Trigger

### **Vacuum won't pick up cleaning solution**

#### Possible Causes

Poor Upholstery/Carpet Tool position  
  
Collection Tank is full  
Upholstery/Carpet Tool Brush worn  
Excess solution in Vacuum Flex Hose  
  
Incorrect switch position on TurboBrush

#### Remedies

Reposition Upholstery/Carpet Tool on surface, follow recommended cleaning procedures  
Empty Collection Tank  
Replace with new Brush  
Lift Tool and point upwards to allow water in Hose to flow into the Collection Tank  
Reposition switch to "Suction" Position

### **Excessive Foam in the Collection Tank**

#### Possible Causes

Residue left in carpet or fabric form prior cleaning  
  
Incorrect cleaning formula

#### Remedies

Flush carpet by using clear water in Solution Tank  
Check Tank often/empty as necessary  
Use BISSELL Little Green formula only

### **TurboBrush attachment-Brush will not turn**

#### Possible Causes

Incorrect switch position on TurboBrush

#### Remedies

Reposition switch to "Brush" position

## BISSELL Consumer Services

For information about repairs or replacement parts, or questions about your warranty, call:

### BISSELL Consumer Services

**1-800-237-7691**

Monday - Friday 8 a.m. — 7 p.m. EST

Saturday 9 a.m. — 2 p.m. EST

Or write:

BISSELL HOMECARE, INC

PO Box 3606

Grand Rapids MI 49501

ATTN: Consumer Services

Or visit the BISSELL website - [www.bissell.com](http://www.bissell.com)

When contacting BISSELL, have model number of unit available.

Please record your Model Number: \_\_\_\_\_

Please record your Purchase Date: \_\_\_\_\_

**NOTE: Please keep your original sales receipt. It provides proof of date of purchase in the event of a warranty claim. See "About Your Warranty" on page 14 for details.**

## Replacement parts - BISSELL Little Green

Item	Part No.	Part Name
1	203-0983	4" Upholstery/Carpet Tool w/Brush
2	203-0961	4" Window
3	203-0984	4" Removable Brush
4	203-0985	6" Upholstery/Carpet Tool w/Brush
5	603-0912	6" Window
6	203-0986	6" Removable Brush
7	203-0987	Spraying Crevice Tool
8	210-1183	TurboBrush
<b>Solution/Clean Tank</b>		
9	203-1200	Little Green
10	603-1224	Little Green TurboBrush
11	203-1209	Little Green ProHeat
12	203-1210	Little Green ProHeat TurboBrush
<b>Collection/Dirty Tank</b>		
13	203-1201	White

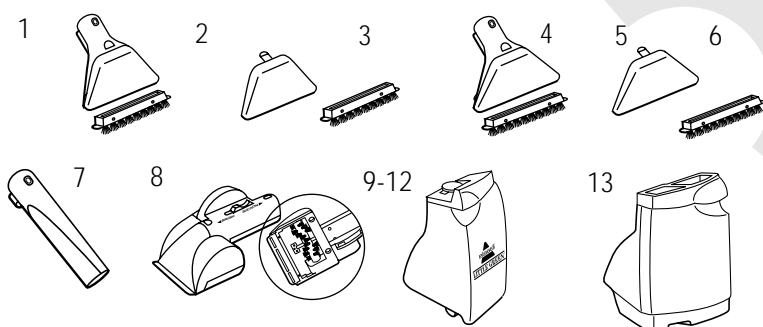

©2001 BISSELL HOMECARE, Inc.  
Grand Rapids, Michigan  
All rights reserved. Printed in USA.  
Part Number 010-5762  
Rev 5/01

Visit our website at:  
[www.bissell.com](http://www.bissell.com)



## About Your Warranty

This warranty gives you specific legal rights, and you may also have other rights which may vary from state to state. If you need additional instruction regarding this warranty or have questions regarding what it may cover, please contact BISSELL Consumer Services by E-mail, telephone, or regular mail as described below.

### Limited **One** Year Warranty

Subject to the \*EXCEPTIONS AND EXCLUSIONS identified below, upon receipt of the product BISSELL Homecare Inc. will repair or replace (with new or remanufactured components or products), at BISSELL's option, free of charge from the date of purchase by the original purchaser, for one year any defective or malfunctioning part.

See information below on "If your BISSELL product should require service".

This warranty applies to product used for personal, and not commercial or rental service. This warranty does not apply to fans or routine maintenance components such as filters, belts, or brushes. Damage or malfunction caused by negligence, abuse, or use not in accordance with the User's Guide is not covered.

### If your BISSELL product should require service:

Call BISSELL Consumer Services at the number below or visit the BISSELL website - **www.bissell.com** to locate a BISSELL Authorized Service Center in your area. If there are no authorized BISSELL Service Centers in your area, select the "Customer Service" tab, and follow the instructions for contacting us via email. A BISSELL Representative will issue you a Return Authorization Number and a pre-paid mailing label to return the unit to BISSELL for warranty repair.

The machine should be returned with a photocopy of your proof of purchase. (Your dated sales receipt is your proof of date of purchase in the event of a warranty claim - do not send original.)

If you need information about repairs or replacement parts, or if you have questions about your warranty, select the "Customer Service" tab on our website and follow the instructions for contacting us by e-mail.

Or call:

#### **BISSELL Consumer Services**

1-800-237-7691

Monday - Friday 8 a.m. - 7 p.m. EST

Saturday 9 a.m. - 2 p.m. .EST

Or write:

#### **BISSELL HOMECARE, INC.**

PO Box 3606

Grand Rapids MI 49501

ATTN: Consumer Services

BISSELL HOMECARE, INC. IS NOT LIABLE FOR INCIDENTAL OR CONSEQUENTIAL DAMAGES OF ANY NATURE ASSOCIATED WITH THE USE OF THIS PRODUCT. BISSELL'S LIABILITY WILL NOT EXCEED THE PURCHASE PRICE OF THE PRODUCT.

Some states do not allow the exclusion or limitation of incidental or consequential damages, so the above limitation or exclusion may not apply to you.

\*EXCEPTIONS AND EXCLUSIONS FROM THE TERMS OF THE **LIMITED** WARRANTY

THIS WARRANTY IS EXCLUSIVE AND IN LIEU OF ANY OTHER WARRANTIES EITHER ORAL OR WRITTEN. ANY IMPLIED WARRANTIES WHICH MAY ARISE BY OPERATION OF LAW, INCLUDING THE IMPLIED WARRANTIES OF MERCHANTABILITY AND FITNESS FOR A PARTICULAR PURPOSE, ARE LIMITED TO THE ONE YEAR DURATION FROM THE DATE OF PURCHASE AS DESCRIBED ABOVE.

Some states do not allow limitations on how long an implied warranty lasts, so the above limitation may not apply to you.