

# BISSELL®

**Earn BISSELL Rewards!**

Register your product today!  
See details on page 2

## PowerGlide™ / Power Trak®

### USER'S GUIDE

#### MODEL 3545 & 6592 SERIES



**3** Safety Instructions

**4** Product View

**5** Assembly

**5-7** Operations / Special Tools

**7-9** Routine Maintenance

**10** Troubleshooting

**11** Replacement Parts

**11** Consumer Services

**12** Warranty

We're glad you purchased a BISSELL vacuum. Everything we know about floor care went into the design and construction of this powerful, high-tech home vacuuming system.

Your BISSELL vacuum is well made, and we back it with a limited comprehensive one year warranty. We also stand behind it with a knowledgeable, dedicated Consumer Services Department, so, should you ever have a problem, you'll receive fast, considerate assistance.

My great-grandfather invented the floor sweeper in 1876. Today, BISSELL is a global leader in the design, manufacture, and service of high quality homecare products like your BISSELL vacuum.

Thanks again, from all of us at BISSELL.

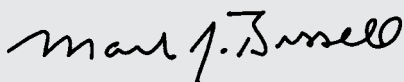

**Mark J. Bissell**  
**President and Chief Executive Officer**



**Don't forget to register your product!**

Registering is quick, easy and offers you benefits over the lifetime of your product. You'll receive:

**BISSELL Rewards Points**

Automatically earn points for discounts and free shipping on future purchases.

**Faster Service**

Supplying your information now saves you time should you need to contact us with questions regarding your product.

**Product Support Reminders and Alerts**

We'll contact you with any important product maintenance reminders and alerts.

**Special Promotions**

Optional: Register your email to receive notice of offers, contests, cleaning tips and more!

**Visit [www.bissell.com/registration](http://www.bissell.com/registration) now!**

# IMPORTANT SAFETY INSTRUCTIONS

When using an electrical appliance, basic precautions should be observed, including the following:

## READ ALL INSTRUCTIONS BEFORE USING YOUR UPRIGHT VACUUM.

Always connect to a polarized outlet (left slot is wider than right). Unplug from outlet when not in use and before conducting maintenance.

**⚠ WARNING:** To reduce the risk of fire, electric shock, or injury:

- Do not modify the polarized plug to fit a non-polarized outlet or extension cord.
  - Do not leave vacuum cleaner unattended when it is plugged in.
  - Unplug from outlet when not in use and before servicing.
  - Do not use outdoors or on wet surfaces.
  - Do not allow children to operate vacuum cleaner or use as a toy.
  - Close attention is necessary when used by or near children.
  - Do not use for any purpose other than described in this User's Guide.
  - Use only manufacturer's recommended attachments.
  - Do not use with damaged cord or plug.
  - If appliance is not working as it should, has been dropped, damaged, left outdoors, or dropped into water, have it repaired at an authorized service center.
  - Do not pull or carry by cord, use cord as a handle, close a door on cord, or pull cord around sharp edges or corners. Do not run appliance over cord. Keep cord away from heated surfaces.
  - Do not unplug by pulling on cord. To unplug, grasp the plug, not the cord.
  - Do not handle vacuum cleaner or plug with wet hands.
  - Do not put any object into openings. Do not use with any opening blocked; keep openings free of dust, lint, hair, and anything that may reduce air flow.
  - Keep hair, loose clothing, fingers, and all parts of body away from openings and moving parts.
- Turn off all controls before plugging or unplugging vacuum cleaner.
  - Use extra care when cleaning stairs.
  - Do not pick up flammable materials (lighter fluid, gasoline, kerosene, etc.) or use in the presence of explosive liquids or vapors.
  - Do not pick up toxic material (chlorine bleach, ammonia, drain cleaner, etc.).
  - Do not use vacuum cleaner in an enclosed space filled with vapors given off by oil base paint, paint thinner, some moth proofing substances, flammable dust, or other explosive or toxic vapors.
  - Do not pick up hard or sharp objects such as glass, nails, screws, coins, etc.
  - Do not pick up anything that is burning or smoking, such as cigarettes, matches, or hot ashes.
  - Do not use without filters in place.
  - Use only on dry, indoor surfaces.
  - Keep appliance on a level surface.
  - Do not carry the vacuum cleaner while it is running.

**WARNING:** The Power Cord on this product contains lead, a chemical known to the State of California to cause birth defects or other reproductive harm. **WASH HANDS AFTER HANDLING.**

## SAVE THESE INSTRUCTIONS FOR FUTURE USE.

## THIS APPLIANCE HAS A POLARIZED PLUG.

To reduce the risk of electric shock, this appliance has a polarized plug (one blade is wider than the other). This plug will fit in a polarized outlet only one way. If the plug does not fit fully in the outlet, reverse the plug. If it still does not fit, contact a qualified electrician to install a proper outlet. Do not change the plug in any way.

This model is for household use only.

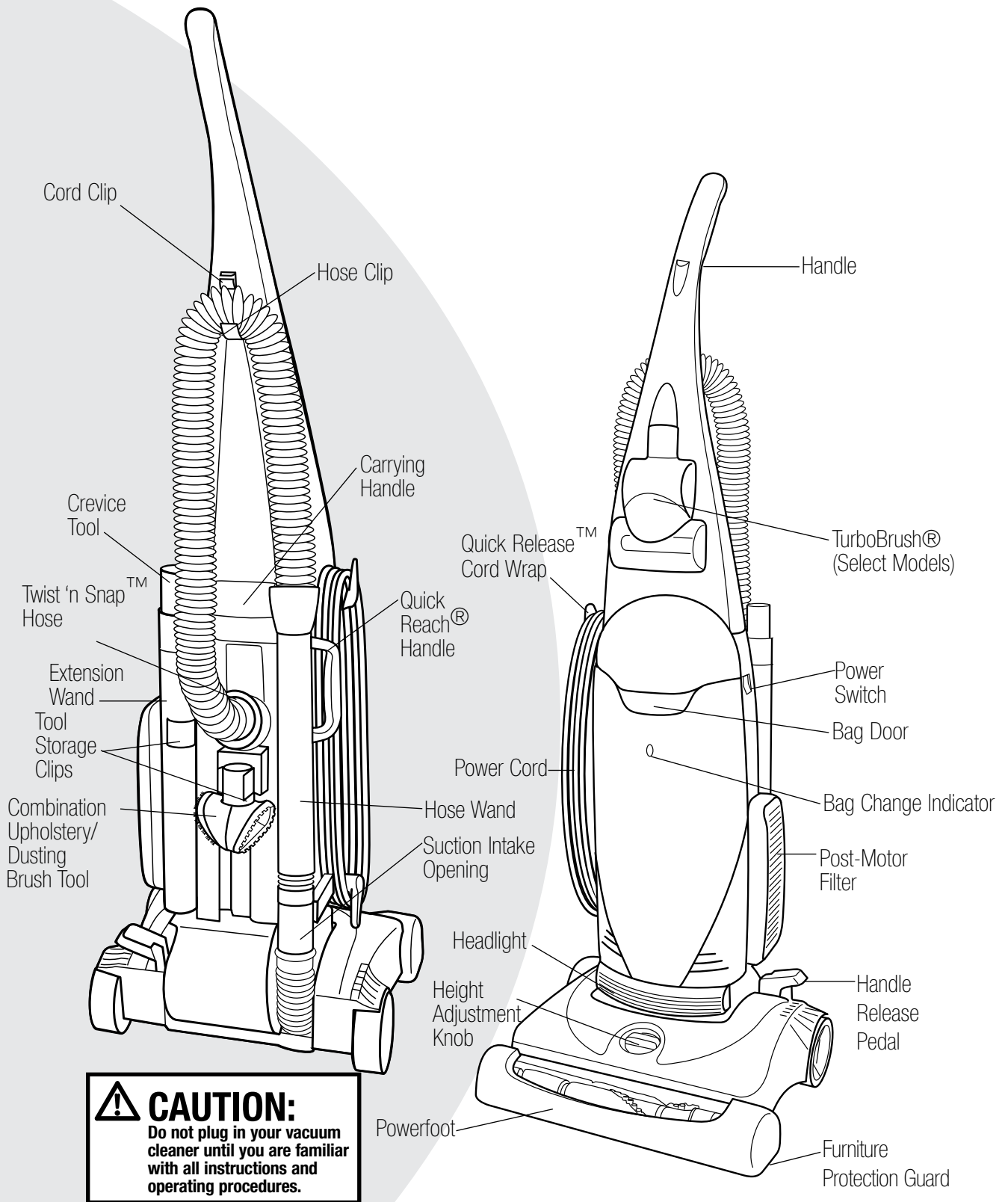

**⚠ CAUTION:**  
 Do not plug in your vacuum cleaner until you are familiar with all instructions and operating procedures.

## How To Use This Guide

This User's Guide has been designed to help you get the utmost satisfaction from your BISSELL vacuum. You'll find assembly and operating instructions, safety precautions, as well as maintenance and troubleshooting instructions. Please read this Guide thoroughly before assembling your vacuum.

Pay particular attention to the product diagram, assembly instructions, and part names. Locate and organize all parts before assembly. Following this User's Guide will greatly enhance your ability to get the most performance from your BISSELL vacuum for many years.



### WARNING:

Plastic film can be dangerous. To avoid danger of suffocation, keep away from babies and children.

## How To Assemble

The only tool you'll need to assemble your vacuum is a screwdriver.

### Attach Handle to Vacuum

1. Stand the vacuum upright and slide the base of the Handle firmly into the grooves at the top of the vacuum body.
2. Check to be sure the Handle is fitted to the vacuum body. If there is a gap in front, continue to push firmly until the Handle is flush.
3. Insert one screw from the assembly packet into the existing hole in the back of the Handle. Tighten securely with a screwdriver.

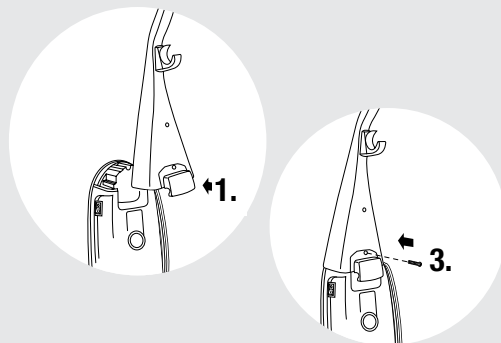

### Attach Vacuum Hose and Tools

1. Position the hose collar on the back of the vacuum as shown.
2. Attach the hose collar with two screws from the assembly packet. Tighten securely with a screwdriver.
3. Line up the tabs on the base of the Twist 'n Snap Hose with the corresponding tab notches on the hose collar as shown. Turn the Twist 'n Snap Hose to the **left** to lock the hose into place.
4. Grasping the Quick Reach® Handle, slide the end of the Hose Wand onto the Suction Intake Opening. Snap the Hose into the Hose Clip.  
**NOTE: The Powerfoot will not operate effectively unless the Hose Wand is firmly attached to the Suction Intake Opening.**
5. Place the Crevice Tool inside the Extension Wand and slide them into the Storage Clip as shown.
6. Snap the Combination Upholstery/Dusting Brush Tool into the Storage Clip as shown.
7. Attach the TurboBrush by aligning the small holes near the brush roll with the tabs at the bottom of TurboBrush housing. Snap TurboBrush into place as shown.

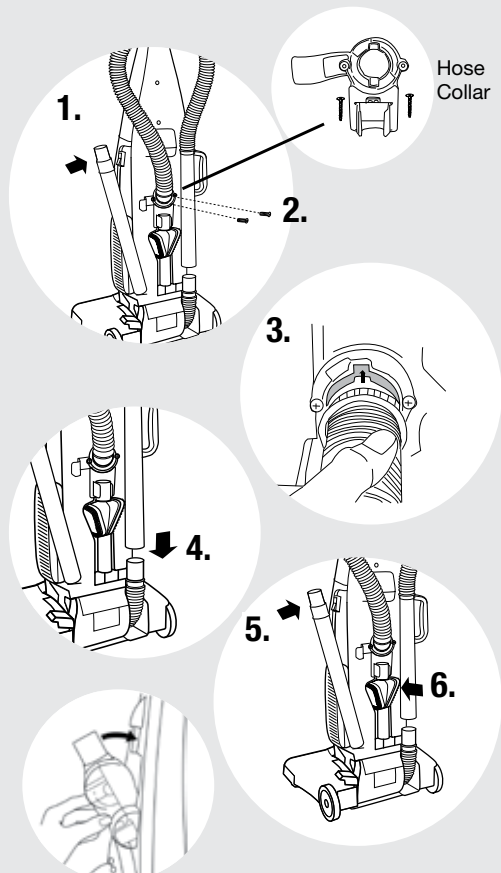

Hose Collar

Select Models Only

## How To Use Your BISSELL Vacuum

### Handle Position

Press the Handle Release Pedal with your foot to place your vacuum into one of three cleaning positions.

1. Upright- For storage and above floor cleaning with special tools.
2. Normal Cleaning- Press Handle Release Pedal once. Use for most household floor cleaning tasks.
3. Low Cleaning- With the vacuum in normal cleaning position press Handle Release Pedal again. Use for reaching under low furniture such as tables, chairs and beds.

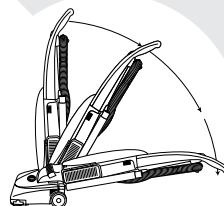

### Tip:

Before cleaning under low furniture, check area first for objects that might harm the unit or block the Vacuum Hose.

## Powerfoot Height Adjustment

The Powerfoot/Rotating Floor Brush on your BISSELL vacuum can be adjusted to clean several floor surfaces.

**NOTE: For optimal cleaning performance, adjust to the lowest practical setting. If your cleaner is difficult to push, adjust to the next higher setting.**

1. Place Handle in Upright Position.
2. Turn Floor Surface Selector to desired setting.  
**Lowest Setting** - For bare floors.  
**Medium Settings** - For short and medium pile carpets.  
**Highest Setting** - For plush pile carpet.
3. Place the Handle into the Normal Cleaning position and the Powerfoot will adjust to the setting chosen.  
**NOTE: You may also adjust the setting while in the Normal Cleaning Position.**

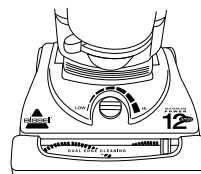

### Tip:

Hair, string and small objects can block the Vacuum Hose or Tools. Check them occasionally for obstructions. See Troubleshooting Guide for instructions.

## Special Tools

Your BISSELL vacuum is not only a powerful carpet and rug vacuum cleaner, it's also a versatile above floor vacuum when you select one of the special tools.

1. Raise Handle to Upright Position.
2. Grasp the Quick Reach Handle and lift up to separate from suction intake opening.
3. Attach tools by firmly pushing onto Hose Wand or Extension Wand.

### Combination Upholstery/Dusting Brush Tool:

Two types of cleaning tools are included in one attachment: rotate for desired tool.

- Use Brush side to dust furniture, blinds, books, lamps, shelves.
- Use Upholstery side for curtains, draperies, cushions, fabrics.

### Crevice Tool:

Use in tight narrow spaces.

### Extension Wand:

Use with desired attachments for a longer reach.

### TurboBrush (Select Models):

Use rotating brush action for small areas such as stairs and upholstery.

**Note: Press gently when using the TurboBrush to gain maximum cleaning. Too much pressure will cause the brush to stop rotating.**

### Stair Cleaning Tool (Select Models):

Use for stairs, area rugs, and other small carpeted area. This tool can also be used for bare floors.

**All items may not be included with your model. More tools are available; to order please refer to page 11.**

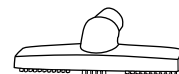
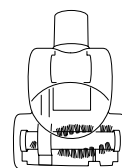
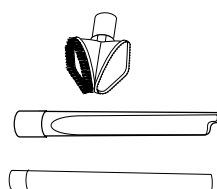
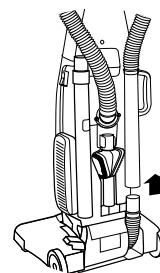

## NOTICE:

The Floor Brush will continue to rotate while you use your vacuum for above floor cleaning. To prevent carpet damage, do not lean on the vacuum or let the Powerfoot tilt forward.



## CAUTION:

The Rotating Floor Brush continues to rotate while tools are in use. To reduce the risk of injury from moving parts, always move the vacuum with the Carrying Handle at the back of the vacuum. Always place vacuum on floor with Handle in Upright position when using tools. Never place your fingers under the vacuum when it is running. Never place Powerfoot on furniture or uneven surfaces. Do not place vacuum close enough to objects to pull them into rotating brush.

## Power Cord

When you are done using your BISSELL vacuum, return it to the Upright position and store the Power Cord.

1. Turn vacuum OFF.
2. Unplug Power Cord by grasping the polarized plug (NOT the cord) and disconnect from outlet.
3. Loop Power Cord around Cord Wraps on side of vacuum.
4. Clip molded plug to Power Cord to secure.

### Tip:

Your BISSELL vacuum features a Quick Release™ Cord Wrap. To remove the Power Cord quickly and easily, rotate the Upper Cord Wrap towards floor, and slip Power Cord from Upper and Lower Cord Wraps.

## Routine Maintenance

To maintain maximum performance from your BISSELL vacuum, perform these simple maintenance checks.

### Bag Change Indicator

Select BISSELL vacuum models are equipped with a Bag Change Indicator. This indicator monitors the airflow through the Dust Bag and turns red to indicate a reduction or blockage. The following conditions may cause it to become completely red.

1. Dust Bag is full; change the bag.
2. Dust Bag is clogged with fine materials; change the bag.
3. Clog in the vacuum; clear the clog.

### Replace Dust Bag

**Never reuse a Dust Bag.**

**Use only BISSELL Style 7 Dust Bags in your BISSELL vacuum.**

**Style 7 Enviro Fresh® Micro Filtration Dust Bags (#30861)**

**Style 7 Dust Bags (#32120).**

1. Unplug cleaner from electrical outlet.
2. Pull the Bag Door outward to open. Set Bag Door aside.
3. Grasp Dust Bag Collar, and pull Collar from Connector Tube. Discard used Dust Bag.
4. Grasp new Dust Bag Collar and push firmly onto Connector Tube. Tuck in Dust Bag.
5. Replace Bag Door by placing tab on bottom of door into opening as shown. Press top of door to snap securely shut.

**NOTE: Vacuum will not suction while the Bag Door is removed.**



## WARNING:

To reduce the risk of electric shock, turn Power Switch OFF and disconnect polarized plug from electrical outlet before performing maintenance or troubleshooting checks.

### Tip:

Vacuuming new carpet or fine powders may clog the Dust Bag, causing the Bag Change Indicator to turn red even though the Dust Bag does not appear to be full. Change the Dust Bag to restore maximum performance.

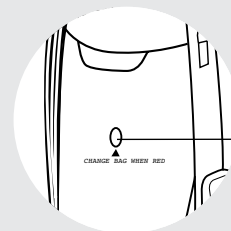

Bag Change Indicator

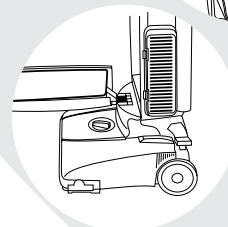
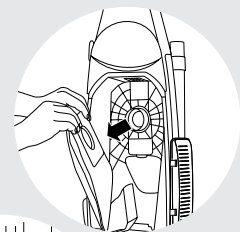

## Cleaning Pre-Motor & Post-Motor Filters

Use only BISSELL Replacement Filters in your BISSELL vacuum.  
Filter Kit (#203-1089)  
Style 7 Post-Motor Filter Set 2 pack (#3099)  
Style 7 Post-Motor Filter (#32076)

1. Unplug vacuum from electrical outlet.
2. The Pre-Motor Filter, located in the bottom of the bag compartment, protects the motor from dirt particles. If filter becomes dirty, lift out filter and clean.
3. The Post-Motor Filter assists in the filtration process to return clean air to the room. To remove this filter, open the door on the side of the cleaner. Grasp filter and pull it straight out.

**Note: Select Models come with a white, pleated filter.  
This filter is not washable and must be replaced.**

4. The filters may be hand washed in cold water with mild detergent, then air dried.
5. Reposition filters when completely dry.

## Check Rotating Floor Brush and Drive Belt

You should check your vacuum cleaner's Rotating Floor Brush and Drive Belt regularly for wear or damage. You should also clean the brush and brush ends of string, hair, and carpet fibers. These can wrap around the brush and hamper its ability to effectively clean your carpet. Also remove any debris that has accumulated under the brush cover.

1. Unplug vacuum from electrical outlet.
2. Place handle in Low position and turn vacuum over so bottom side is up.
3. Remove the five screws as shown with a screwdriver. Lift the Brush Cover off.
4. Grasp Rotating Floor Brush at both ends and lift.
5. Clean strings, hair and other debris from Rotating Floor Brush, paying particular attention to brush ends.
6. Clean strings, hair and other debris from Motor Pulley and Drive Belt areas.
7. Check Drive Belt carefully for wear, cuts or stressed areas. Replace if worn.
8. Check Air Passageway for obstructions. Remove debris from this area.

## Replace Drive Belt

Use only BISSELL Style 7 Replacement Belts (#32074) in your BISSELL vacuum.

1. Unplug cleaner from electrical outlet.
2. With Rotating Floor Brush removed from vacuum cleaner (Steps 1-4 of Check Rotating Floor Brush and Drive Belt), grasp old Drive Belt and remove from Motor Pulley. Discard old Drive Belt.
3. Place new Drive Belt over Motor Pulley and stretch other end over Rotating Floor Brush in the space between the bristles.
4. Place ends of Rotating Floor Brush down into slots on sides as shown.
5. Turn Rotating Floor Brush by hand several times in direction of Motor Pulley. If properly installed, Drive Belt will center itself.
6. Reposition Brush Cover and five screws. Tighten screws securely. Make sure end of Brush Cover is snapped into place.

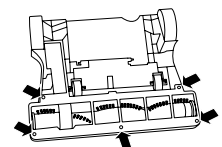
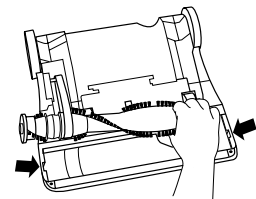
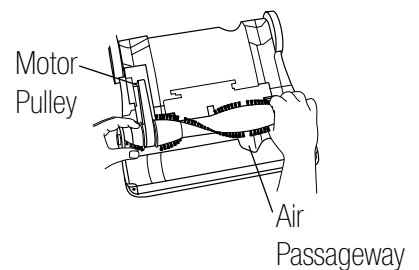
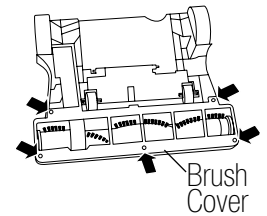
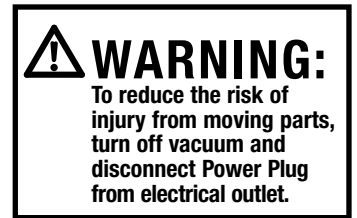
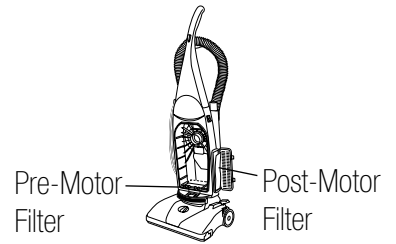



## Replace Light Bulb

(Select Models)

Use only BISSELL Replacement Bulbs in your BISSELL Vacuum.

1. Unplug cleaner from electrical outlet.
2. Using a Phillips head screwdriver, remove the two screws as shown and lift off the lens.
3. Determine the light bulb type of your vacuum:  
Standard Bulb (#203-1297) – approximately 1" long, flat end.  
Large Bulb (#203-1007) – approximately 2" long, round end.
4. **Standard Bulb** – remove the bulb from the socket by grasping bulb and pulling straight out. Install the new bulb by pushing it gently into the socket until the bulb snaps into place.  
**Large Bulb** – remove the bulb from the socket by pushing in gently and turning it towards brush. Install the new bulb by pushing it gently into the socket and turning away from the brush.

5. Reposition lens and secure with the two screws.

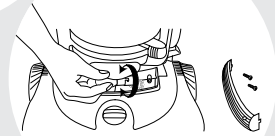
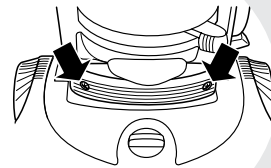

Large Bulb

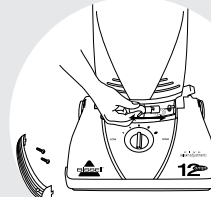

Standard Bulb

## Clearing Clogs

The Hose on the back of the vacuum that carries the dirt from the Powerfoot to the Dust Bag can sometimes become clogged. If you notice a change in the sound of the vacuum motor, check for clogs.

1. Unplug vacuum from electrical outlet.
2. Pull the Bag Door outward to open and set aside. Remove the Dust Bag to check the Suction Inlet for a clog.
3. Grasp the Quick Reach Handle and lift up to separate from the Suction Intake Opening. Release the Twist 'n Snap Hose from the vacuum by turning to the **right**. Straighten the hose and unclog with a long, narrow object.
4. If the clog persists, turn the vacuum OFF and unplug it. Remove the Brush Cover. Check the Air Passageway for obstructions. Remove debris from this area. Reposition Brush Cover and five screws. Tighten screws securely. Make sure end of Brush Cover is snapped into place.

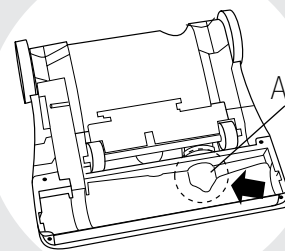
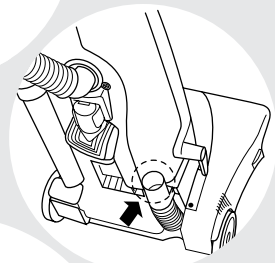
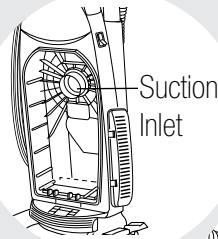

Air Passageway

## Maintaining TurboBrush

**Select Models Only**

The TurboBrush should be checked regularly for clogs or debris wrapping around the brush roll.

1. Unplug vacuum from electrical outlet.
2. If a clog is present or debris is visible, unscrew the two screws on the back of the TurboBrush to remove the faceplate and clear any obstructions.
3. To clean debris from the brush roll, remove the screw located by the brush roll with a Phillips head screwdriver. Lift the belt cover. Remove the brush roll from the drive belt and clean debris.
4. Reposition the drive belt on the brush roll. Place ends of brush roll in slots on sides as shown. Reposition belt cover and secure with one screw. Reposition faceplate and secure with two screws.

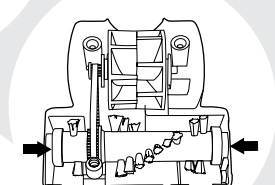
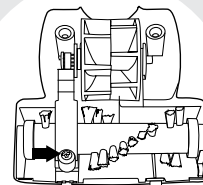
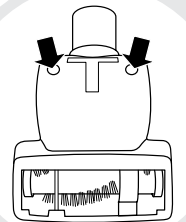

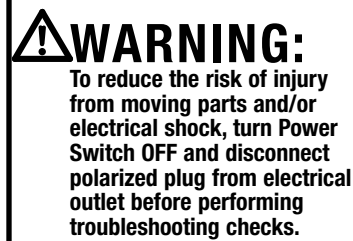

### Vacuum cleaner won't run.

#### Possible Causes

- Power cord not firmly plugged in
- Blown household fuse or breaker

#### Remedies

- Check electrical plug.
- Check/replace fuse - Reset breaker.

### Vacuum cleaner won't pick up dirt.

#### Possible Causes

- Incorrect Height Adjustment
- Hose wand not attached to suction opening
  
- Twist 'n Snap Hose not securely attached
  
- Dust Bag is full
- Broken or worn Drive Belt
- Rotating Floor Brush bristles worn
- Rotating Floor Brush jammed
- Clog in vacuum

#### Remedies

- Adjust Powerfoot to correct height setting.
- Grasp Quick Reach Handle and firmly push Hose Wand onto the suction opening.
- Make sure Twist 'n Snap Hose is snapped into the locked position
- Replace with new Dust Bag.
- Replace Drive Belt.
- Replace Brush.
- Remove Brush and clean debris from brush ends.
- Follow instructions for clearing clogs.

### Tools won't pick up dirt.

#### Possible Causes

- Crack or hole in Hose
- Vacuum Hose, Wand or Tools clogged

#### Remedies

- Replace Hose.
- Follow instructions for clearing clogs.

### Vacuum cleaner is difficult to push.

#### Possible Causes

- Incorrect Height Adjustment
- Rotating Floor Brush not rotating

#### Remedies

- Turn Floor Surface Selector to next highest setting.
- Check Drive Belt and Brush.

If suggested remedies do not correct the problem, call:

**BISSELL Consumer Services**

**1-800-237-7691**

**Monday - Friday**

**8 a.m. — 10 p.m. ET**

**Saturday**

**9 a.m. — 8 p.m. ET**

or visit the **BISSELL website - [www.bissell.com](http://www.bissell.com)**

## Replacement Parts

You may purchase replacement parts from your retailer, by calling BISSELL Consumer Services or by visiting our website. To locate a retailer near you, or to place an order using VISA, MasterCard, Discover or American Express, call:

### BISSELL Consumer Services

**1-800-237-7691**

Monday - Friday 8 a.m. — 10 p.m. ET

Saturday 9 a.m. — 8 p.m. ET

Or visit our Website - [www.bissell.com](http://www.bissell.com)

Item	Part No.	Part Name
1	30861	Style 7 Enviro Fresh® Micro Filtration Dust Bags (3 pack)
2	32120	Style 7 Dust Bags (3 pack)
3	32074	Style 7 Drive Belt (2-Pack)
4	203-1007	Large Headlight Bulb
5	203-1297	Standard Headlight Bulb
6	203-1063	Crevice Tool
7	203-1099	Combination Upholstery / Dusting Brush
8	203-1022	Extension Wand
9	203-1227	TurboBrush
10	203-1261	Wire Reinforced Twist 'n Snap Vacuum Hose (clear)
11	203-1129	Hose Collar with Screws
12	203-2013	Brush Roll
13	203-1089	Filter Kit
14	203-6624	Stair Cleaning Tool
15	3099	Style 7 Post-Motor Filter Set (2 pack)
16	32076	Style 7 Post-Motor Filter



1/2

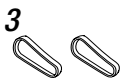

3



4/5

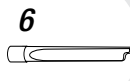

6



7

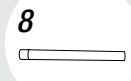

8

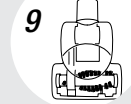

9



10

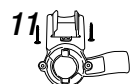

11

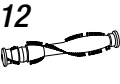

12



13

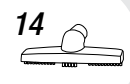

14



15



16

## BISSELL Consumer Services

**For information about repairs or replacement parts, or questions about your warranty, call:**

### BISSELL Consumer Services

**1-800-237-7691**

**Monday - Friday 8 a.m. — 10 p.m. ET**

**Saturday 9 a.m. — 8 p.m. ET**

### Or write:

BISSELL Homecare, Inc.  
PO Box 3606  
Grand Rapids MI 49501  
ATTN: Consumer Services

Or visit the BISSELL website - [www.bissell.com](http://www.bissell.com)

**When contacting BISSELL, have model number of unit available.**

**Please record your Model Number:** \_\_\_\_\_

**Please record your Purchase Date:** \_\_\_\_\_

**NOTE: Please keep your original sales receipt. It is your warranty.**

## About Your Warranty

This warranty gives you specific legal rights, and you may also have other rights which may vary from state to state. If you need additional instruction regarding this warranty or have questions regarding what it may cover, please contact BISSELL Consumer Services by E-mail, telephone, or regular mail as described below.

### Limited One Year Warranty

Subject to the \*EXCEPTIONS AND EXCLUSIONS identified below, upon receipt of the product BISSELL Homecare, Inc. will repair or replace (with new or remanufactured components or products), at BISSELL's option, free of charge from the date of purchase by the original purchaser, for one year any defective or malfunctioning part.

See information below on "If your BISSELL product should require service".

This warranty applies to product used for personal, and not commercial or rental service. This warranty does not apply to fans or routine maintenance components such as filters, belts, bags, or brushes. Damage or malfunction caused by negligence, abuse, neglect, unauthorized repair, or any other use not in accordance with the User's Guide is not covered.

### If your BISSELL product should require service:

Contact BISSELL Consumer Services to locate a BISSELL Authorized Service Center in your area.

If you need information about repairs or replacement parts, or if you have questions about your warranty, contact BISSELL Consumer Services.

#### Website or E-mail:

[www.bissell.com](http://www.bissell.com)

Use the "Customer Service" tab.

#### Or Call:

BISSELL Consumer Service

1-800-237-7691

Monday - Friday 8 a.m. - 10 p.m. ET

Saturday 9 a.m. - 8 p.m. ET

#### Or write:

BISSELL Homecare, Inc.

PO Box 3606

Grand Rapids MI 49501

ATTN: Consumer Services

**PLEASE KEEP YOUR DATED RECEIPT. YOUR RECEIPT SERVES AS PROOF OF YOUR PURCHASE DATE AND IS USED TO DETERMINE THE WARRANTY. IF YOUR MACHINE SHOULD NEED TO BE REPAIRED, TAKE YOUR RECEIPT WITH YOU TO EXPEDITE THE TRANSACTION.**

**BISSELL HOMECARE, INC. IS NOT LIABLE FOR INCIDENTAL OR CONSEQUENTIAL DAMAGES OF ANY NATURE ASSOCIATED WITH THE USE OF THIS PRODUCT. BISSELL'S LIABILITY WILL NOT EXCEED THE PURCHASE PRICE OF THE PRODUCT.**

Some states do not allow the exclusion or limitation of incidental or consequential damages, so the above limitation or exclusion may not apply to you.

### \*EXCEPTIONS AND EXCLUSIONS FROM THE TERMS OF THE LIMITED WARRANTY

**THIS WARRANTY IS EXCLUSIVE AND IN LIEU OF ANY OTHER WARRANTIES EITHER ORAL OR WRITTEN. ANY IMPLIED WARRANTIES WHICH MAY ARISE BY OPERATION OF LAW, INCLUDING THE IMPLIED WARRANTIES OF MERCHANTABILITY AND FITNESS FOR A PARTICULAR PURPOSE, ARE LIMITED TO THE ONE YEAR DURATION FROM THE DATE OF PURCHASE AS DESCRIBED ABOVE.**



©2013 BISSELL Homecare, Inc.  
Grand Rapids, Michigan  
All rights reserved. Printed in Korea.  
Part Number 110-4288  
Rev 09/13

Visit our website at:  
[www.bissell.com](http://www.bissell.com)