

PowerGroom®

BAGLESS VACUUM

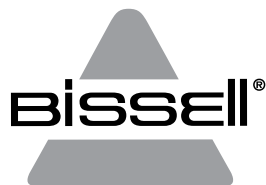

USER'S GUIDE 92L3 SERIES

- 3 **Safety Instructions**
- 4 **Product View**
- 5-6 **Assembly**
- 6-10 **Operations**
- 11-16 **Maintenance and Care**
- 16-17 **Troubleshooting**
- 18 **Consumer Services**
- 18 **Replacement Parts**
- 19 **Additional Accessories**
- 20 **Warranty**



Thanks for buying a BISSELL Vacuum

We're glad you purchased a BISSELL vacuum. Everything we know about floor care went into the design and construction of this complete, high-tech home cleaning system.

Your BISSELL vacuum is well made, and we back it with a limited two year warranty. We also stand behind it with a knowledgeable, dedicated Consumer Services department, so, should you ever have a problem, you'll receive fast, considerate assistance.

My great-grandfather invented the floor sweeper in 1876. Today, BISSELL is a global leader in the design, manufacture, and service of high quality homecare products like your BISSELL vacuum .

Thanks again, from all of us at BISSELL.

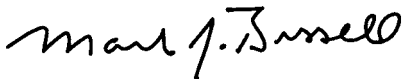

Mark J. Bissell

Chairman, President & CEO

IMPORTANT SAFETY INSTRUCTIONS

When using an electrical appliance, basic precautions should be observed, including the following:

READ ALL INSTRUCTIONS BEFORE USING YOUR UPRIGHT VACUUM.

Always connect to a polarized outlet (left slot is wider than right). Unplug from outlet when not in use and before conducting maintenance.

WARNING: To reduce the risk of fire, electric shock, or injury:

- Do not modify the polarized plug to fit a non-polarized outlet or extension cord.
- Do not leave vacuum cleaner unattended when it is plugged in.
- Unplug from outlet when not in use and before servicing.
- Unplug before attaching the TurboBrush.
- Do not use outdoors or on wet surfaces.
- Do not allow children to operate vacuum cleaner or use as a toy.
- Close attention is necessary when used by or near children.
- Do not use for any purpose other than described in this user's guide.
- Use only manufacturer's recommended attachments.
- Do not use with damaged cord or plug.
- If appliance is not working as it should, has been dropped, damaged, left outdoors, or dropped into water, have it repaired at an authorized service center.
- Do not pull or carry by cord, use cord as a handle, close a door on cord, or pull cord around sharp edges or corners. Do not run appliance over cord. Keep cord away from heated surfaces.
- Do not unplug by pulling on cord. To unplug, grasp the plug, not the cord.
- Do not handle vacuum cleaner or plug with wet hands.
- Do not put any object into openings. Do not use with any opening blocked; keep openings free of dust, lint, hair, and anything that may reduce air flow.
- Keep hair, loose clothing, fingers, and all parts of body away from openings and moving parts.

- Turn off all controls before plugging or unplugging vacuum cleaner.
- Use extra care when cleaning stairs.
- Do not pick up flammable materials (lighter fluid, gasoline, kerosene, etc.) or use in the presence of explosive liquids or vapors.
- Do not pick up toxic material (chlorine bleach, ammonia, drain cleaner, etc.).
- Do not use vacuum cleaner in an enclosed space filled with vapors given off by oil base paint, paint thinner, some moth proofing substances, flammable dust, or other explosive or toxic vapors.
- Do not pick up hard or sharp objects such as glass, nails, screws, coins, etc.
- Do not pick up anything that is burning or smoking, such as cigarettes, matches, or hot ashes.
- Do not use without filters in place.
- Use only on dry, indoor surfaces.
- Keep appliance on a level surface.
- Do not carry the vacuum cleaner while it is running.

SAVE THESE INSTRUCTIONS FOR FUTURE USE

THIS APPLIANCE HAS A POLARIZED PLUG.

To reduce the risk of electric shock, this appliance has a polarized plug (one blade is wider than the other). This plug will fit in a polarized outlet only one way. If the plug does not fit fully in the outlet, reverse the plug. If it still does not fit, contact a qualified electrician to install a proper outlet. Do not change the plug in any way.

This model is for household use only.

Product view

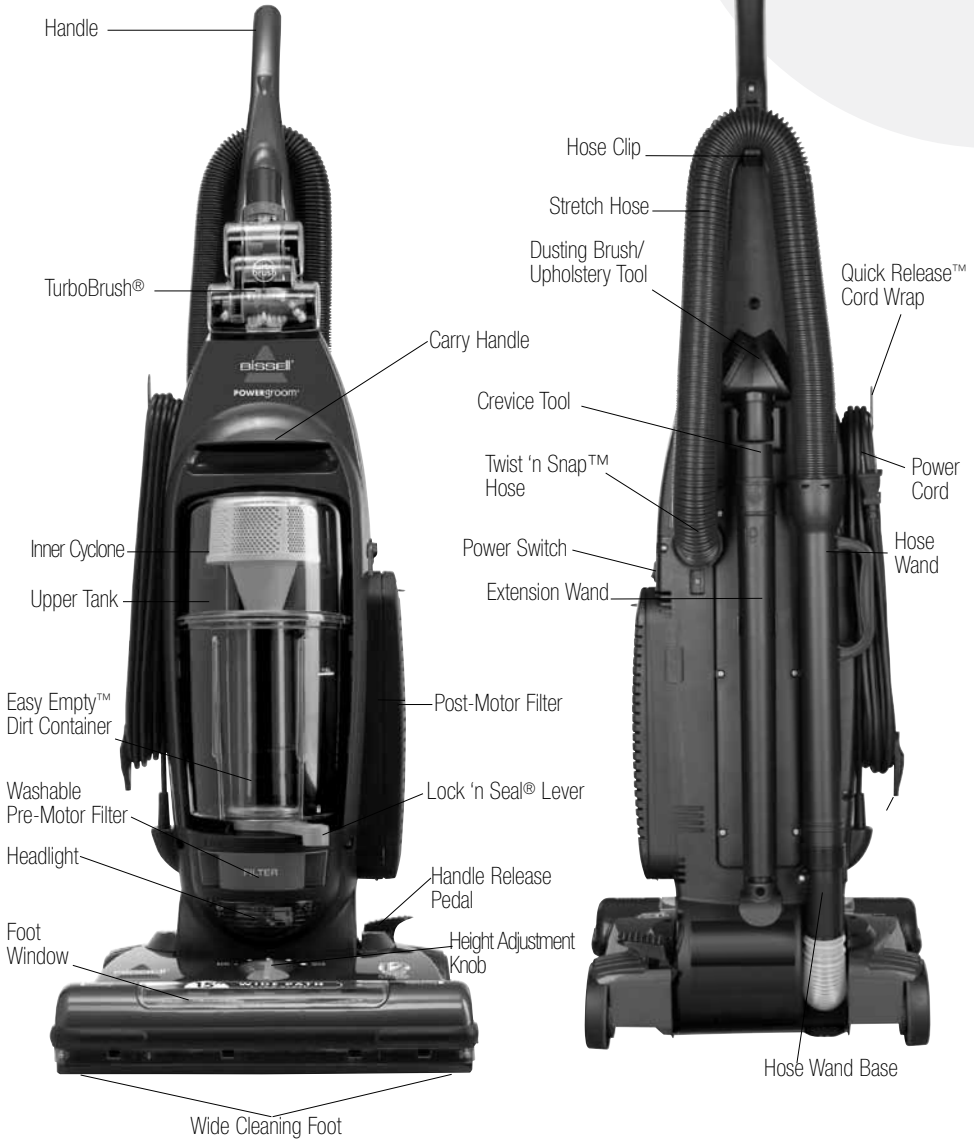

Assembly

The only tool you'll need to assemble your vacuum cleaner is a Phillips screwdriver.

Attach handle to vacuum

1. Locate the handle and cord wrap. Remove the screw packet taped to the handle.
2. Stand the vacuum upright and from the rear of the unit, slide the base of the handle firmly into the grooves at the top of the vacuum body.
3. Ensure that the handle fits firmly to the vacuum body. If there are any gaps, continue to push firmly until the handle is secure.
4. Insert the provided screw into the existing hole, attaching the handle to the body of the vacuum. Tighten securely with a screwdriver.

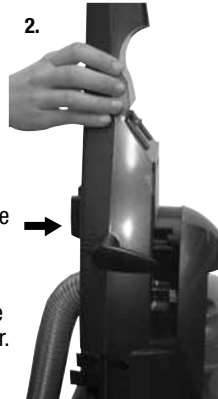

⚠ CAUTION:
Do not plug in your vacuum cleaner until you are familiar with all instructions and operating procedures.

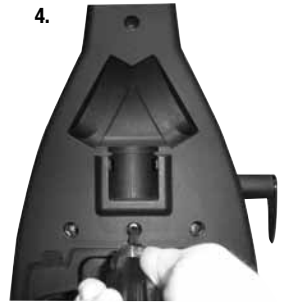

Assembly

Attach vacuum hose and tools

1. Attach the Twist 'n Snap™ Hose by lining up the tabs on the base with the corresponding notches on the back of the vacuum as shown.
2. Turn the Twist 'n Snap Hose to the right to lock the hose into place.
3. Grasping the Quick Reach Handle, slide the end of the Hose Wand onto the Hose Wand Base. Snap the Hose into the Hose Clip.
NOTE: The vacuum will not operate effectively unless the hose wand is firmly attached.
4. Slide the extension wand and crevice tool into the storage clip on back of vacuum.
5. Slide the dusting brush/upholstery tool into the storage clip on back of vacuum.
6. Store the TurboBrush on the front of the handle by lining up the TurboBrush base with the base of the holder then push back to snap into place.

Power switch

The Power Switch is located on the left side of the vacuum. Push the rocker switch “ON” (I) to vacuum, and “OFF” (O) when cleaning is complete.

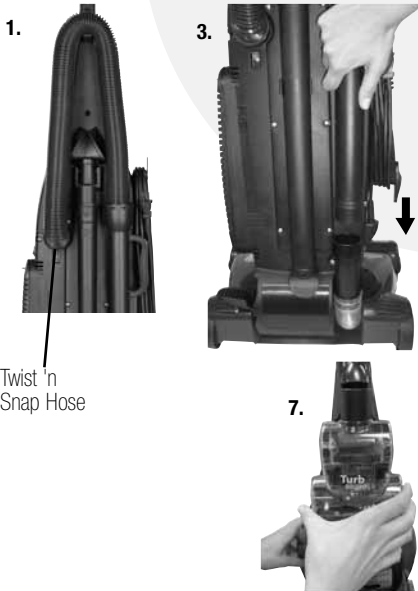

CAUTION:

Before using your vacuum, make sure that the dirt container is in the locked position and that all filters (pre-motor and post-motor filter) are in place. Do not operate your vacuum without these filters.

NOTICE:

For above floor cleaning, the floor brush will continue to rotate, but is raised above floor. To prevent carpet damage, do not lean on the vacuum or let the powerfoot tilt forward.



CAUTION:

To avoid personal injury and to prevent the cleaner from falling when cleaning stairs, always place it at the bottom of the stairs.

Operations

Handle positions

Press the handle release pedal, located on the lower left side of the vacuum, with your foot to place your vacuum into one of three cleaning positions.

1. **Upright** – For storage and above floor cleaning with tools.
2. **Normal Cleaning** – Press handle release pedal once. Position used for most household floor cleaning tasks.
3. **Low Cleaning** – With the vacuum in normal cleaning position, press handle release pedal again. Use for reaching under low furniture such as tables, chairs or beds.

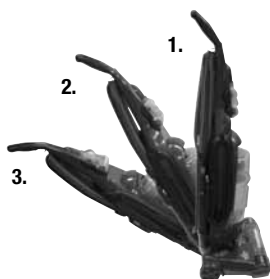

Tip:

Before cleaning under low furniture, check area first for objects that might harm the unit or block the vacuum hose.

Height adjustment

There are five height settings available for various floor surfaces. Turn the dial on the foot of the cleaner to the desired setting.

Lowest setting – For low pile carpet or bare floors. To pick up debris it may be necessary to move up one setting.

Medium settings – For medium pile carpet.

High setting – For high pile and most shag carpet.

Note: For optimal carpet cleaning performance, adjust to the lowest practical setting. If your cleaner is difficult to push, adjust to the next higher setting.

If the dial is difficult to turn, tilt the cleaner back slightly to take the weight off the foot while turning.

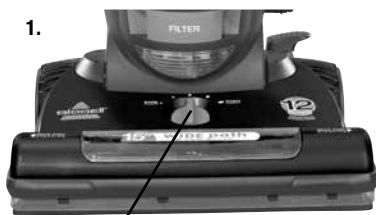

Height Adjustment Knob

Operations

Transporting cleaner

1. To move your cleaner from room to room, put the handle in the upright position, tilt the cleaner back on its rear wheels and push forward.
2. The cleaner can also be moved by using the carry handle.

Special on-board tools

Your vacuum is not only a powerful carpet and rug cleaner, it's also a versatile above floor vacuum cleaner when you select one of the special tools.

1. Raise the handle to the upright position.
2. Grasp the hose wand handle to separate from hose wand base.
3. Attach tools by firmly pushing onto vacuum hose, hose wand or extension wand. Be sure the hose and tool fit snugly together by twisting tightly.

Dusting Brush/Upholstery Tool: Two types of cleaning tools in one attachment.

- Use brush side to dust furniture, blinds, books, lamps, shelves and baseboards.
- Use upholstery side for cushions, draperies and fabrics.

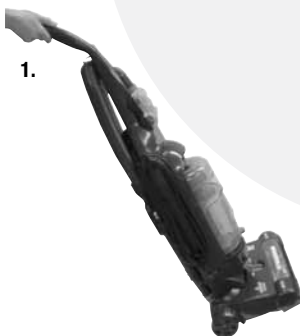

2. correct way to carry



Operations

Special on-board tools (continued)

Crevice Tool: Use in tight narrow spaces.

Extension Wand: Use with desired attachment for a longer reach.

Hose Wand: Use with desired attachment for a longer reach or for cleaning hard to reach places.

TurboBrush: Use rotating brush action for small flat areas such as cushions and beds.

NOTE: Press gently down and pull towards you in a raking motion. Too much pressure will cause the brush to stop rotating.



Tip:

Hair, string and small objects can block the vacuum hose or tools. Check them occasionally for obstructions.

CAUTION:

The rotating floor brush continues to rotate while tools are in use. To reduce the risk of injury from moving parts, always move the cleaner with the carrying handle. Always place vacuum cleaner on the floor with handle in upright position when using tools. Never place your fingers under the cleaner when it is running. Never place powerfoot on furniture or uneven surfaces. Do not place vacuum cleaner close enough to objects to pull them into rotating brush.

Operations

Power cord usage

1. To use your vacuum, remove the cord and plug it into an electrical outlet. For your convenience, there is a quick release cord wrap for easy cord removal. There is also a cord clip that is part of the upper cord wrap where you can attach the cord when vacuuming.
2. When you are finished cleaning, turn vacuum cleaner off.
3. Unplug power cord by grasping the polarized plug (NOT the cord) and disconnect from outlet.
4. Loop power cord around cord wraps on side of vacuum cleaner. Be sure to first return the quick release cord wrap back to its original position before wrapping the cord.
5. Clip molded plug to power cord to secure.



Maintenance and care

To maximize your cleaning performance and extend the life of your vacuum, it is very important that you empty your dirt container and check and clean your filters frequently. Perform the following maintenance steps:

1. Empty the dirt container when the dirt reaches the "Full" line on the container, or more frequently to prevent overfills. For best performance, empty after each use.
2. Check the pre-motor filter and clean or replace as necessary.
3. Check the post-motor post-motor filter and replace as needed.

NOTE: More frequent filter cleaning may be necessary if you are vacuuming new carpet, fine dust, or have allergy concerns. Follow the instructions on the following pages to perform these simple maintenance steps.

Empty dirt container

The dirt container should to be emptied before the dirt reaches the "Full" line on the container.

1. Unplug the vacuum from electrical outlet.
2. Slide the Lock 'n Seal Lever to the "Unlock" position.
3. Grasp handle and pull the dirt container straight out to remove from the vacuum.
4. Empty dirt into garbage container.

NOTE: Emptying the dirt container after every use will help prevent over filling and ensure that the vacuum is ready to go the next time you clean.



WARNING:

To reduce the risk of electric shock, turn power switch OFF and disconnect polarized plug from electrical outlet before performing maintenance or troubleshooting checks.

Tip:

To maximize cleaning performance, check and clean or replace all filters as suggested.

1. Unplug the vacuum from electrical outlet.
2. Slide the Lock 'n Seal Lever to the "Unlock" position.
3. Grasp handle and pull the dirt container straight out to remove from the vacuum.
4. Empty dirt into garbage container.

NOTE: Emptying the dirt container after every use will help prevent over filling and ensure that the vacuum is ready to go the next time you clean.

2.



Unlock

4.



Maintenance and care

Cleaning the pre-motor and post-motor filter

1. Unplug the vacuum from electrical outlet.
2. The pre-motor filter protects the motor from dirt particles. It is located in the slide out tray underneath the dirt container. If the filter becomes dirty, pull out the tray, lift out the foam filter pad and clean it.
NOTE: The pre-motor filter may be hand washed in cold water with mild detergent. Rinse well and air dry thoroughly before replacing.
3. The post-motor filter assists in the filtration process to return clean air to the room. It is located behind the door on the side of the vacuum. If the filter becomes dirty, remove the door, remove the filter and replace.

NOTE: The post-motor filter is a white, pleated filter. This filter is not washable and must be replaced when it becomes dirty.

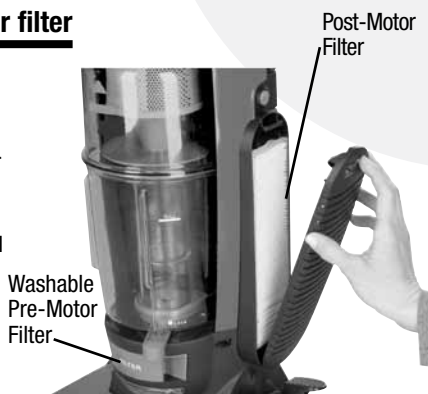

⚠ WARNING:
Do not operate cleaner with damp or wet filters or without all filters in place.

Check rotating floor brush and drive belt

You should check your vacuum cleaner's rotating floor brush and drive belt regularly for wear or damage. You should also clean the brush and brush ends of strings, hair and carpet fibers. This type of debris can wrap around the brush and hamper its ability to effectively clean your carpet. Also remove any debris that has accumulated under the brush cover.

1. Unplug the vacuum from electrical outlet.
2. Place handle in low position and turn vacuum cleaner over so bottom side is facing up.
3. Lift tab 1 and release the three latches in order 2-4 marked. Lift off the brush cover.
4. Grasp rotating floor brush at both ends and lift.
5. Clean strings, hair and other debris from rotating floor brush, paying particular attention to brush ends.
6. Clean strings, hair and other debris from motor pulley and drive belt areas.
7. Check drive belt carefully for wear, cuts or stressed areas.
8. Check air passageway for obstructions. Remove debris from this area.

⚠ WARNING:
To reduce the risk of injury from moving parts, turn vacuum cleaner off and disconnect power plug from electrical outlet.

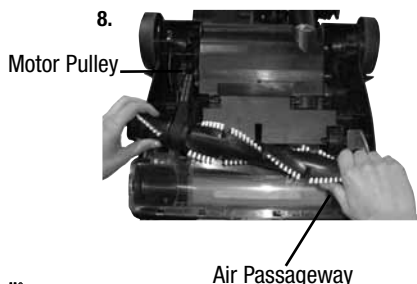
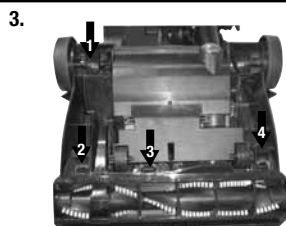

Maintenance and care

Replace drive belt

1. Unplug the vacuum from electrical outlet.
2. With rotating floor brush removed from vacuum cleaner (Steps 1-4 of check rotating floor brush and drive belt), grasp old drive belt and remove from motor pulley. Discard the old drive belt.

3. Place new drive belt over motor pulley and loop other end over rotating floor brush in the space between the bristles.

NOTE: It is important that you use only genuine BISSELL replacement belts. Generic belts may not meet the exact specifications required to keep your vacuum operating at its peak performance. The use of unbranded belts could lead to early failure of the vacuum and could void your warranty.

4. Pull the rotating floor brush firmly into position, stretching the drive belt, and place ends of rotating floor brush down into the slots on sides as shown. Alignment of brush ends in slots may be necessary to fully insert the brush.
5. Turn rotating floor brush by hand several times in the direction of motor pulley. If properly installed, drive belt will center itself on rotating brush crown.
6. Insert front edge of brush cover, rotate into place, and snap 3 latches.

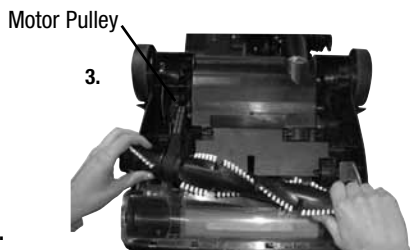

Maintenance and care

Replacing lightbulb

1. Unplug the vacuum from electrical outlet.
2. Using a screwdriver, first remove 2 screws on either side of lens and pull out to remove the lens.
3. Remove the bulb from the socket by grasping the bulb and pulling gently. Install the new bulb by pushing it gently into the socket until the bulb snaps into place.
4. Reposition the lens place cover back over headlight and reinsert 2 screws.



3.



4.



Maintaining TurboBrush®

The TurboBrush should be checked regularly for clogs or debris wrapping around the brush.

1. Remove tool from hose or front of vacuum.
2. Twist collar so opening is at the top and lift top cover to remove.
3. Remove the brush from the belt and clean debris.
4. Replace the brush inside the belt and place ends into slots on sides as shown.
5. Reposition top cover making sure to line up inside tab at the front with the opening on the cover. Twist collar until opening is at the bottom to lock into place.

2.



4.



5.

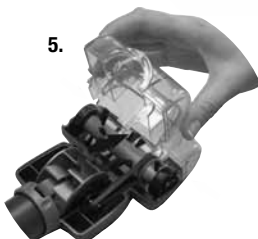

Maintenance and care

Clearing clogs

Low suction or poor pickup may be due to a clog in the vacuum cleaner. If you notice a change in the sound of the motor, check for clogs.

1. Unplug the vacuum from electrical outlet.
2. Empty dirt container.
3. Check upper tank for build up or clogs.
4. If you notice a clog in the upper tank, remove the inner cyclone (see section "Cleaning the upper tank" on page 16).
5. Grasp the hose wand and separate it from the hose wand base. Check for a clog in the base, the wand or in the hose.
6. Remove the Twist 'n Snap hose from the vacuum by turning to the **left**. Straighten the hose and unclog with a long, narrow object such as a broom handle.
7. If the clog persists, follow the instructions for "Checking the rotating floor brush and drive belt" on page 12 and inspect the air passageway for obstructions.



Maintenance and care

Cleaning the upper tank

1. Grasp the inner cyclone and twist to the left until the locking tabs stop the rotation. Pull down from the upper tank to remove it.
2. Wipe out the inside of the upper tank and the inner cyclone with a damp cloth moistened with water or a mild cleaning solution.
3. If you desire to thoroughly clean the filtration disk located in the upper portion of the inner cyclone, hold the bottom of the cyclone and turn filtration disk to the right and pull up to remove.
4. The inner cyclone and filtration disk may be washed using a mild detergent. Be sure it is completely dry before reassembling or damage to your unit may result.
5. Once cleaning is completed, reassemble the filtration disk over the inner cyclone by sliding it straight down on the top of the inner cyclone and turning left. Be sure to line up the tabs when reassembling for proper installation.
6. To replace the inner cyclone, slide it into the upper housing. Be sure to line up the inner cyclone by ensuring tabs on filtration disk are positioned toward the front of the unit. Push the inner cyclone in and rotate it to the right until the locking tabs stop the rotation.

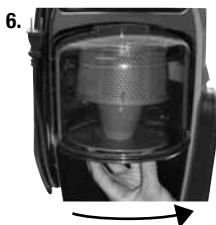
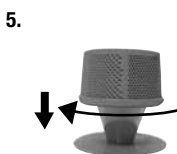
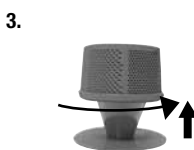

Troubleshooting

Vacuum cleaner won't run

Possible causes

1. Power cord not plugged in
2. Blown fuse/tripped breaker in home



WARNING:

To reduce the risk of electric shock, turn power OFF and disconnect polarized plug from electrical outlet before performing maintenance or troubleshooting.

Remedies

1. Check electrical plug
2. Check/replace fuse or reset breaker

Troubleshooting

Vacuum cleaner won't run (continued)

Possible causes

3. Damaged power cord

Remedies

3. Unplug, check for damage, replace as necessary

Vacuum cleaner and tools won't pick up dirt

Possible causes

1. Incorrect height adjustment
2. Hose not attached to suction opening
3. Twist 'n Snap hose not securely attached
4. Crack or hole in hose
5. Broken or worn drive belt
6. Rotating floor brush bristles worn
7. Rotating floor brush jammed
8. Clog in vacuum
9. Dirt container full
10. Dirt container not installed properly
11. Filters are dirty
12. TurboBrush is clogged or debris is wrapped around the brush roll

Remedies

1. Adjust powerfoot to correct height
2. Firmly push hose wand into hose wand base
3. Make sure Twist 'n Snap hose is snapped into locked position
4. Check hose and replace if needed
5. Replace drive belt, see page 13
6. Replace brush
7. Remove brush and clean debris from brush ends
8. Clear clogs, see page 15
9. Empty dirt container
10. Position correctly and lock in place
11. Check pre-motor and post-motor filters
12. See page 14 for Maintaining TurboBrush

Vacuum cleaner is difficult to push

Possible causes

1. Incorrect height setting

Remedies

1. Adjust powerfoot to correct height setting

Visible dirt escaping from cleaner

Possible causes

1. Dirt container full
2. Filters missing or installed incorrectly
3. Dirt container installed incorrectly

Remedies

1. Empty dirt container
2. Check pre-motor and post-motor filters for correct installation
3. Pull out and re-insert dirt container correctly

Other maintenance or service not included in the manual should be performed by an authorized service representative.

Thank you for selecting a BISSELL product.

Please do not return this product to the store.

For any questions or concerns, BISSELL is happy to be of service.
Contact us directly at 1-800-237-7691.

BISSELL Consumer Services

For information about repairs or replacement parts, or questions about your warranty, call:

BISSELL Consumer Services
1-800-237-7691

Monday - Friday 8 a.m. — 10 p.m. ET

Saturday 9 a.m. — 8 p.m. ET

Or write:

BISSELL Homecare, Inc.

PO Box 3606

Grand Rapids MI 49501

ATTN: Consumer Services

Or visit the BISSELL website - **www.bissell.com**

When contacting BISSELL, have model number of cleaner available.

Please record your Model Number: _____

Please record your Purchase Date: _____

NOTE: Please keep your original sales receipt. It provides proof of purchase date in the event of a warranty claim. See Warranty on page 20 for details.

Replacement parts - BISSELL vacuum

Item	Part No.	Part Name
1	303-1120	Style 7/9/10/12/14 Drive Belt (2-Pack)
2	203-1297	Headlight Bulb
3	203-1283	Wide Window Foot Brush Roll (gray)
4	203-1073	Style 7/8/14 Pre-Motor Foam Filter
5	203-6608	Style 8/14 Post-Motor Filter

1



2



3



4



5



Additional accessories

These items are available for purchase as accessories for your BISSELL PowerGroom:
To purchase call 1-800-237-7691 or visit www.bissell.com.

Item	Part No.	Part Name
1	203-1056	Crevice Tool
2	203-1059	Dusting Brush/Upholstery Tool
3	203-1429	TurboBrush
4	203-1068	Extension Wand
5	203-1216	Twist 'n Snap Vacuum Hose (clear)

1



2



3



4



5



Warranty - BISSELL PowerGroom® Vacuum

This warranty gives you specific legal rights, and you may also have other rights which may vary from state to state. If you need additional instruction regarding this warranty or have questions regarding what it may cover, please contact BISSELL Consumer Services by E-mail, telephone, or regular mail as described below.

Limited Two Year Warranty

Subject to the ***EXCEPTIONS AND EXCLUSIONS** identified below, upon receipt of the product BISSELL Homecare, Inc. will repair or replace (with new or remanufactured components or products), at BISSELL's option, free of charge from the date of purchase by the original purchaser, for two years any defective or malfunctioning part.

See information below on "If your BISSELL product should require service".

This warranty applies to product used for personal, and not commercial or rental service. This warranty does not apply to fans or routine maintenance components such as filters, belts, or brushes. Damage or malfunction caused by negligence, abuse, neglect, unauthorized repair, or any other use not in accordance with the User's Guide is not covered.

If your BISSELL product should require service:

Contact BISSELL Consumer Services to locate a BISSELL Authorized Service Center in your area.

If you need information about repairs or replacement parts, or if you have questions about your warranty, contact BISSELL Consumer Services.

Website or E-mail:

www.bissell.com

Use the "Customer Services" tab.

Or Call:

BISSELL Consumer Services

1-800-237-7691

Monday - Friday 8 a.m. - 10 p.m. ET

Saturday 9 a.m. - 8 p.m. ET

Or Write:

BISSELL Homecare, Inc.

PO Box 3606

Grand Rapids, MI 49501

ATTN: Consumer Services

BISSELL HOME CARE, INC. IS NOT LIABLE FOR INCIDENTAL OR CONSEQUENTIAL DAMAGES OF ANY NATURE ASSOCIATED WITH THE USE OF THIS PRODUCT. BISSELL'S LIABILITY WILL NOT EXCEED THE PURCHASE PRICE OF THE PRODUCT.

Some states do not allow the exclusion or limitation of incidental or consequential damages, so the above limitation or exclusion may not apply to you.

*EXCEPTIONS AND EXCLUSIONS FROM THE TERMS OF THE LIMITED WARRANTY

THIS WARRANTY IS EXCLUSIVE AND IN LIEU OF ANY OTHER WARRANTIES EITHER ORAL OR WRITTEN. ANY IMPLIED WARRANTIES WHICH MAY ARISE BY OPERATION OF LAW, INCLUDING THE IMPLIED WARRANTIES OF MERCHANTABILITY AND FITNESS FOR A PARTICULAR PURPOSE, ARE LIMITED TO THE TWO YEAR DURATION FROM THE DATE OF PURCHASE AS DESCRIBED ABOVE.

Some states do not allow limitations on how long an implied warranty last so the above limitation may not apply to you.



©2013 BISSELL Homecare, Inc.
Grand Rapids, Michigan
All rights reserved. Printed in China
Part Number 160-3166
Rev 9/13
Visit our website at:
www.bissell.com

