



BISSELL®

WE MEAN CLEAN

PowerSteamer®

USER'S GUIDE

1692/1693/1694 PowerSteamer® Series
8805/8806 PowerSteamer® Series

3 Safety Instructions

4 Product View

5 Assembly Instructions

5-11 Operations / Special Tools

11 Maintenance

13-14 Troubleshooting

14 Consumer Services

15 Replacement Parts

16 Warranty

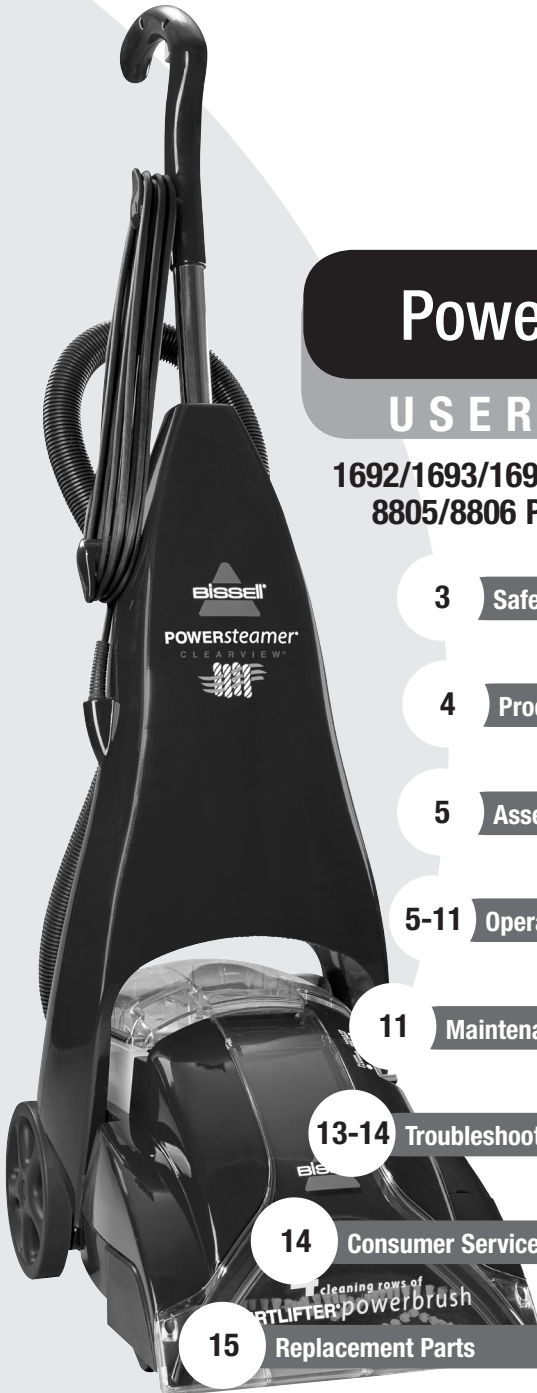



Thanks For Buying A BISSELL PowerSteamer Deep Cleaner

We're glad you purchased a BISSELL PowerSteamer Deep Cleaner. Everything we know about floor care went into the design and construction of this complete, high-tech home cleaning system.

Your PowerSteamer is well made, and we back it with a limited one-year warranty. We also stand behind it with a knowledgeable, dedicated Consumer Services department, so, should you ever have a problem, you'll receive fast, considerate assistance.

My great-grandfather invented the floor sweeper in 1876. Today, BISSELL is a global leader in the design, manufacture, and service of high quality homecare products like your PowerSteamer.



Mark J. Bissell
President and Chief Executive Officer

IMPORTANT SAFETY INSTRUCTIONS

When using an electrical appliance, basic precautions should be observed, including the following:

Read all instructions before using your POWERSTEAMER®.

WARNING:

To reduce the risk of fire, electric shock, or injury.

- Do not immerse
- Use only on surfaces moistened by cleaning process
- Always connect to a properly grounded outlet. See Grounding Instructions
- Unplug from outlet when not in use and before conducting maintenance or troubleshooting
- Do not leave machine when it is plugged in
- Do not service machine when it is plugged in
- Do not use with damaged cord or plug
- If appliance is not working as it should, has been dropped, damaged, left outdoors or dropped into water, have it repaired at an authorized Service Center
- Use indoors only
- Do not pull or carry by cord, use cord as a handle, close door on cord, pull cord around sharp corners or edges, run appliance over cord, or expose cord to heated surfaces
- Do not carry the appliance while in use
- Do not unplug by pulling on cord-unplug by grasping plug not the cord
- Do not handle plug or appliance with wet hands
- Do not put any object into appliance openings, use with blocked opening, or restrict air flow
- Do not expose hair, loose clothing, fingers or body parts to openings or moving parts
- Do not pick up hot or burning objects
- Do not pick up flammable or combustible materials (lighter fluid, gasoline, kerosene, etc.) or use in the presence of explosive liquids or vapor
- Do not use appliance in an enclosed space filled with vapors given off by oil base paint, paint thinner, some moth proofing substances, flammable dust, or other explosive or toxic vapors
- Do not pick up toxic material (chlorine bleach, ammonia, drain cleaner, gasoline, etc.)
- Do not modify the 3-prong grounded plug
- Do not allow to be used as a toy
- Do not use for any purpose other than described in this User's Guide
- Do not operate the appliance unless the belt door is securely assembled in the location provided
- Use only manufacturer's recommended attachments
- Use only cleaning products formulated by BISSELL for use in this appliance to prevent internal component damage. See the Cleaning fluid Section of this manual
- Keep openings free of dust, lint, hair, etc.
- Keep appliance on a level surface
- Turn off all controls before unplugging

- Be extra careful when cleaning stairs
- Close attention is necessary when used by or near children

WARNING: The Power Cord on this product contains lead, a chemical known to the State of California to cause birth defects or other reproductive harm.

WASH HANDS AFTER HANDLING.

SAVE THESE INSTRUCTIONS.

THIS MODEL IS FOR HOUSEHOLD USE ONLY. Commercial use of this unit voids the manufacturer's warranty.

GROUNDING INSTRUCTIONS

This appliance must be connected to a grounded wiring system. If it should malfunction or break down, grounding provides a safe path of least resistance for electrical current, reducing the risk of electrical shock. The cord for this appliance has an equipment-grounding conductor and a grounding plug. It must only be plugged into an outlet that is properly installed and grounded in accordance with all local codes and ordinances.

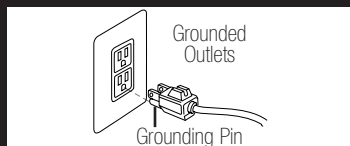

 **WARNING:** Improper connection of the equipment-grounding conductor can result in a risk of electrical shock. Check with a qualified electrician or service person if you aren't sure if the outlet is properly grounded. **DO NOT MODIFY THE PLUG.** If it will not fit the outlet, have a proper outlet installed by a qualified electrician. This appliance is designed for use on a nominal 120-volt circuit, and has a grounding attachment plug that looks like the plug in the drawing above. Make certain that the appliance is connected to an outlet having the same configuration as the plug. No plug adapter should be used with this appliance.

Product View

⚠️ WARNING:

To reduce the risk of fire, use only BISSELL Advanced Deep Cleaning Formulas in your PowerSteamer. Use of cleaning formulas that contain lemon or pine oil may damage this appliance and void warranty. Chemical spot cleaners or solvent-based soil removers should not be used. These products may react with the plastic materials used in your PowerSteamer causing cracking or pitting.

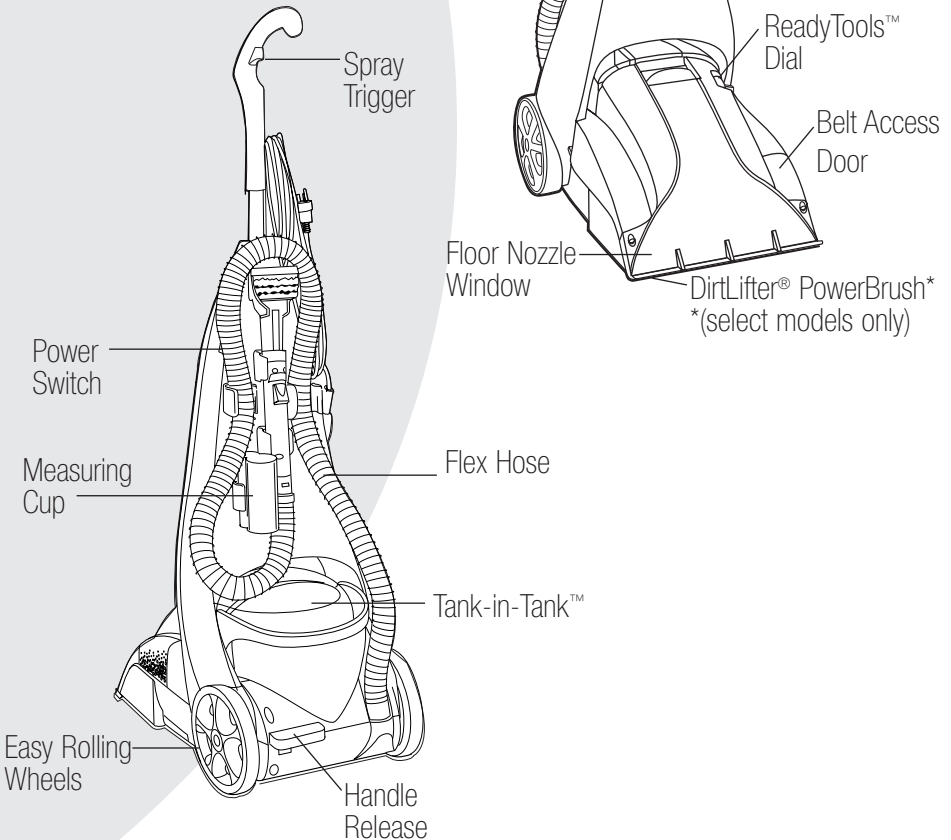

How To Use This Guide

This User's Guide is designed to help you get maximum satisfaction from your PowerSteamer Deep Cleaner. Enclosed you'll find assembly instructions for cleaning tasks, safety precautions, cleaning tips, maintenance and troubleshooting information. Please read this guide thoroughly before assembling and using your cleaner. Pay particular attention to the assembly diagram, assembly instructions, and part names. Locate and organize all parts before assembly. Familiarize yourself with all parts and features and how they operate. Following the Guide will enhance your ability to get top performance from your cleaner for many years.

If you have any questions, or comments please call BISSELL Consumer Services at 1-800-237-7691.

How To Assemble

Your PowerSteamer assembles in two quick steps. The only tool you will need to assemble your cleaner is a Phillips head  screwdriver.

Your PowerSteamer is packaged as two primary components... the Lower Body and the Handle Assembly. To assemble:

1. Slide the Handle Assembly (with attached Quick Release Cord Wrap™) down into the Lower Body until it will go no further.
2. Secure the handle by placing one (1) Phillips head  screw (supplied) through the screw opening in the Lower Body and into the rear of the Handle Assembly. Tighten with screwdriver until secure.

Assembly is now complete.

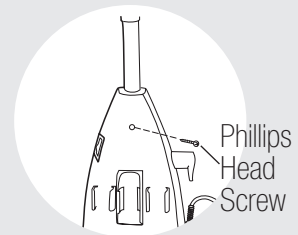
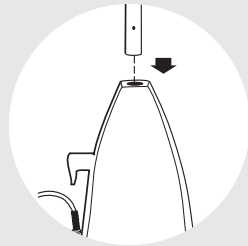

What Comes With Your PowerSteamer



Tough Stain Brush



16oz. Fiber Cleansing Formula with Scotchgard™ protector

Keep plenty of BISSELL Advanced Deep Cleaning Formulas on hand so you can clean whenever it fits your schedule. Always use BISSELL deep cleaning formulas. Non-BISSELL cleaning solutions may harm your cleaner and void the warranty.

The Basics: How Your PowerSteamer Works

Power

The Power Switch controls power to the machine.

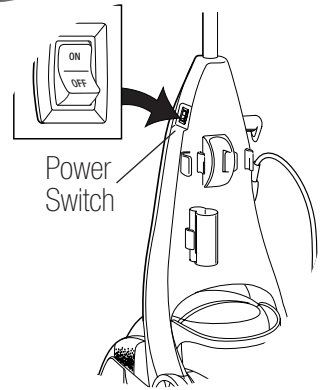

DirtLifter® PowerBrush (on select models)

The powered brush roll at the Floor Nozzle is designed to enhance cleaning performance. The bristle pattern lifts out the deep down dirt while gently grooming carpet fibers. The floating suspension self-adjusts to all carpet heights and protects your carpet if you leave the Power Switch ON. When the machine handle is in the fully upright position, CarpetSaver™ automatically raises the brush off the carpet.

Tip:

Deep cleaning carpeting and upholstery regularly can reduce dust and allergens in your home.

Measuring Cup

Your PowerSteamer is equipped with a Measuring Cup for adding the proper amount of cleaning formula to the Tank-in-Tank™. Before using the machine, simply fill the Measuring Cup to the fill line with BISSELL Advanced Deep Cleaning Formula. Pour the formula into the Tank-in-Tank as shown on page 7. For convenience, the Measuring Cup stores on the back of the unit.

WARNING:
To reduce the risk of fire, electric shock or injury unplug from outlet before servicing.

To Fill The Tank-in-Tank™

This easy-to-use system is designed with a bladder inside to hold clean water. As you clean, the bladder will empty. Dirty water collects in the tank outside the bladder.

NOTE: Make sure to add formula to the tank before filling it with water.

1. Depress the Handle Release pedal to tilt back the handle.
2. Lift the Tank-in-Tank handle. The handle locks the lid in place. Carry the Tank-in-Tank like a bucket to fill at the sink.
3. Set the Tank down and rotate the handle forward to unlatch the Lid. Lift off and set the Lid aside.

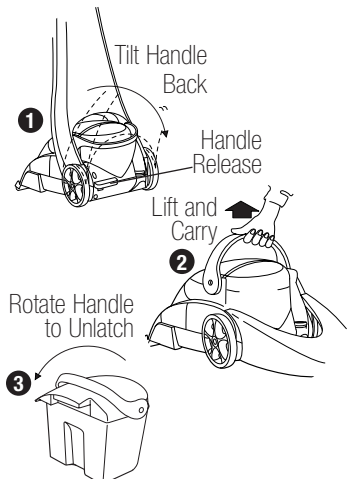

To Fill The Tank-in-Tank (Continued)

- Using the Measuring Cup, pour BISSELL Deep Cleaning Formula into the mouth of the bladder.
- Fill to the bottom of the neck with hot tap water. Do not boil or microwave water.

NOTE: Fill slowly to reduce sudsing.

- Replace the Tank Lid, matching the Lid and Tank edges. Rotate the handle to carrying position. Replace Tank in machine base, seating firmly in place. Rotate handle back down to latched position.

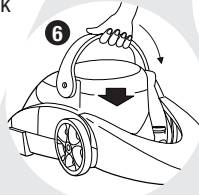
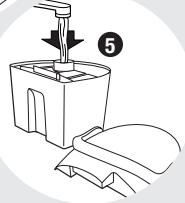

When It's Time To Empty The Tank-in-Tank

NOTE: Remove the Tank-in-Tank, following steps 1 through 3 on page 6.

- Pour out dirty water.
- After each use, remove and rinse the Lint Screen located on the Tank Lid.
 - Remove Tank Lid, follow step 3 on page 6.
 - Remove Lint Screen. Rinse under faucet to remove any debris.
 - Insert Lint Screen back in Tank Lid. The screen will click into place.
 - Replace Tank Lid.
- Refill with cleaning solution and clean tap water, follow steps 4-5 above.

NOTE: When a cleaning job is complete, rinse out the Tank-in-Tank by running clean water between the bladder and the tank.

- Return the Tank-in-Tank to the machine, follow step 6 above.
- Refer to the Maintenance/Storage section on the next page for final cleanup.

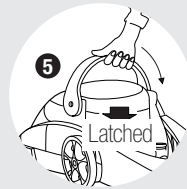
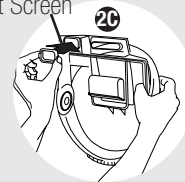
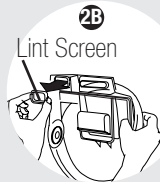
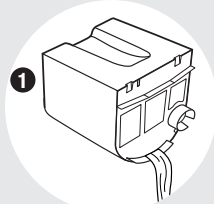

Tip:

A special red float device in the tank will cause the cleaner to stop removing solution from the carpet. The motor sound will rise in pitch to let you know the dirty water tank is full.

ReadyTools™ Dial

This provides floor or upholstery cleaning with the turn of a dial. For carpet/floor cleaning make sure the dial is set to **FLOOR CLEANING**. For upholstery or fabric cleaning, select your cleaning tool, attach it to the Flex Hose, switch to **Tools Settings** and the PowerSteamer is ready to clean upholstery, fabrics and more*

*Set the switch to **FLOOR CLEANING** when cleaning carpets, or set it to **TOOLS/PRETREAT** when using the Flex Hose attachments.

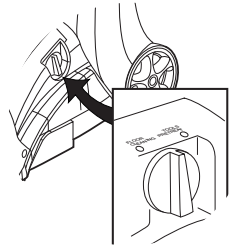

How To Clean Carpet

1. Plan activities to give carpet time to dry.
2. Remove easily moved furniture from the room (chairs, lamps, coffee tables, etc).
3. Vacuum thoroughly to pick up loose debris and pet hair before using the PowerSteamer
4. Plan your cleaning route to leave an exit path. It is best to begin cleaning in the corner farthest from your exit.

NOTE: You may notice hair and debris deposits on carpet that were loosened by brushing action (especially with newer carpets that have never been deep cleaned before). This debris should be picked up by hand and thrown away. Debris that deposits in the brush belt area should be cleaned out to keep Belts running free.

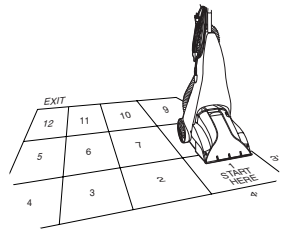

Pretreating

Improves cleaning effectiveness for heavily soiled carpet in high traffic areas such as entryways and hallways:

1. Set the ReadyTools™ dial to **TOOLS/PRETREAT**.
2. Plug the PowerSteamer into a proper outlet and turn ON the Power switch.
3. While pressing the trigger, slowly make several passes over the area to be cleaned. **Caution: Do not overwet.**

4. Turn the machine Power switch OFF and let BISSELL Advanced Deep Cleaning Formula dissolve the tough soil for 1-2 minutes. Reset the ReadyTools Dial to **FLOOR CLEANING** before continuing.

Normal Cleaning

1. Plug the PowerSteamer into a proper outlet and turn ON the Power switch.
2. While pressing the Spray Release Trigger, make one slow forward and back wet pass. Let the BISSELL Advanced Deep Cleaning Formula and DirtLifter PowerBrush* do the work for you. **Caution: Do not overwet.**
3. Release the trigger and make one slow forward and back pass over the same area to remove any residual dirty water.
4. Repeat cleaning passes without pressing the trigger until you can't see any more water being suctioned up.
5. When cleaning job is complete, refer to the Maintenance/Storage section on page 11.

Tip:

Thorough vacuuming before deep cleaning will prevent early clogging of the lint trap.

Cleaning Fluid Section

Keep plenty of genuine BISSELL Fiber Cleansing Formula™ on hand so you can clean and protect whenever it fits your schedule. Always use genuine BISSELL deep cleaning formulas.

WARNING:

To reduce the risk of fire and electric shock due to internal component damage, use only BISSELL cleaning fluids intended for use with the deep cleaner. Non-BISSELL cleaning solutions may harm the machine and void the warranty.



48 oz. BISSELL Fiber Cleansing Formula™ with Scotchgard™ Protector
#0710



48 oz. BISSELL Multi-Allergen Removal™ Formula™ with Scotchgard™ Protector
#0720



48 oz. BISSELL Pet Odor and Soil Removal™ Formula™ with Scotchgard™ Protector
#0730



48 oz. BISSELL Natural Orange Extract Formula™ with Scotchgard™ Protector
#0740



48 oz. BISSELL Lavender Essence Formula™ with Scotchgard™ Protector
#0750



43 oz. BISSELL 3X Concentrated Fiber Cleansing Formula™ with Scotchgard™ Protector
#0716



32 oz. BISSELL Hard Floor Solutions™ Formula
#0484



22 oz. BISSELL Tough Stain PreCleaner™
#0400

Cleaning Bare Floors

The Bare Floor Tool (available with select models only) provides effective cleaning for linoleum, vinyl, and tile floors. Caution: Do not use on hardwood floors.

1. Use only BISSELL Hard Floor Solutions™.
2. Vacuum or sweep thoroughly to pick up loose debris and pet hair.
3. Remove easily moved furniture from the room, (chairs, tables, etc).
4. Plan your cleaning route to leave an exit path.
5. Plan activities to allow about 30 minutes for the floor to dry completely.

Attach The Bare Floor Tool

1. Step on the handle release to lay the machine handle down.
2. Remove the Tank-in-Tank™ from the machine base.
3. Lift the machine base to expose the underside of the nozzle.
4. Attach Bare Floor Tool to nozzle with long tab to the right side (ReadyTools™ side) of the nozzle.
5. First attach left side (short tab) catching tab over nozzle edge.
6. Gently bend long tab (right side) outward to easily snap over edge of clear nozzle on right.

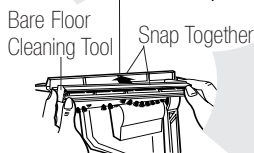
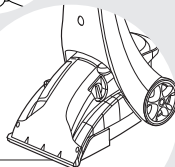
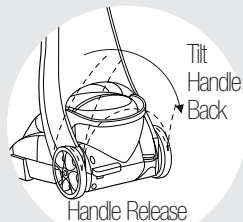

Machine Preparation

1. Set up machine following the instructions in The Basics on pages 6-9. Be sure to thoroughly rinse out any remaining Fiber Cleansing Formula from the Tank-in-Tank bottle to prevent slippery linoleum, vinyl, and tile floors. Use BISSELL Hard Floor Solutions in the Tank-in Tank.
2. Check ReadyTools dial - it should be set on Floor Cleaning.
3. Plug into a proper outlet and turn Power Switch ON.

Bare Floor Cleaning Technique

1. Slowly move the machine nozzle with Bare Floor Tool forward and back over soiled surface one time while pressing the trigger. **Caution: Do not over wet.**
2. Repeat the motion without pressing the trigger using the Bare Floor Tool to squeegee and suction up the dirty water.
3. Repeat steps 1 and 2 backing along the exit path.
4. Allow about 30 minutes for the floor to dry completely.
5. When the cleaning job is complete refer to the **Maintenance/Storage** section on page 11.
6. To remove Bare Floor Tool gently bend long tab (right side) outward and pull tool down away from nozzle. Rinse thoroughly, dry and store.



How To Clean Upholstery and Small Areas

Important - Check Upholstery Tags

Check manufacturer's tag before cleaning. "W" or "WS" on the tag means you can use your PowerSteamer. If the tag is coded with "X" or "S" (with a diagonal strike through), or says "Dry Clean Only," do not proceed. Do not use on velvet or silk. If manufacturer's tag is missing or not coded, check with your furniture dealer.

Check for colorfastness in an inconspicuous place.

If possible, check upholstery stuffing. Colored stuffing may bleed through fabric when wet.

Plan activities to give upholstery time to dry.

Vacuum thoroughly to pick up loose debris and pet hair. Use a vacuum with a brush attachment and a crevice tool to clean lin fabric folds and tufts.

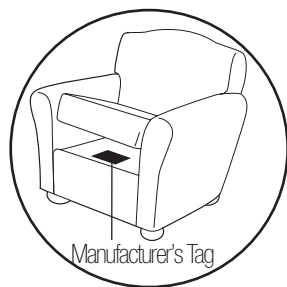

Machine Preparation

1. Set up the machine following instructions in The Basics section, on pages 6-9.
2. Using the Measuring Cup provided, pour BISSELL Advanced Deep Cleaning Formula into the Tank-in-Tank.
3. Set the ReadyTools™ dial to Tools or PreTreat.

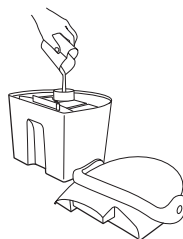

Maintenance/Storage

1. Turn Power switch OFF.
2. Unplug power cord from the outlet and coil around Power Cord Quick Release.
3. Remove and rinse tools in clean, running water, let dry and replace in tool caddy.
4. Coil flex hose through storage brackets.
5. Remove Tank-in-Tank™, dispose of dirty water. See The Basics section, on page 6.
6. Rinse out the Tank-in-Tank™ and reseat the tank onto the machine.
7. Wipe all exterior surfaces with a soft cloth.
8. Store cleaner upright in a protected, dry area.
9. When carpet is dry, vacuum again to remove hair and fuzz that the POWERSTEAMER may have loosened.

Flex Hose
Storage Bracket

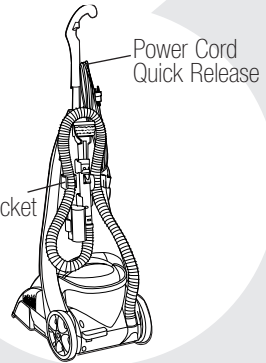

Pump Belt and Brush Belt Replacement

1. Turn the machine off and unplug from wall outlet.
2. Step on the release pedal and recline the handle down onto floor.
3. Remove the Tank-in-Tank. Set them aside.
4. Remove Belt Access Door located near the ReadyTools Dial. Insert a flat head screwdriver into the slot nearest to the handle and gently prying the access door off.
5. Turn the machine onto its side so the belt access area is facing upward.
6. On the bottom of the machine, near the belt access area, is a Red Retainer Plate that holds the black brush arm and brush in place. Using a Phillips head screwdriver remove the screw that holds the Red Retainer Plate in place. Set Red Retainer Plate and Phillips head screw aside.
NOTE: For 1693 Model series, remove stationary brush (skip step 6 and 7)
7. Remove the black brush arm that holds the brush in place. Set the black brush arm aside.
8. Remove the “toothed” Brush Belt from the Brush then from the Red Pump Pulley. Set the “toothed” Brush Belt and Brush aside.
9. Locate and remove the broken Pump Belt.

CAUTION:
PowerSteamer uses water and must not be stored where there is a danger of freezing. Freezing will damage internal components and void the warranty.

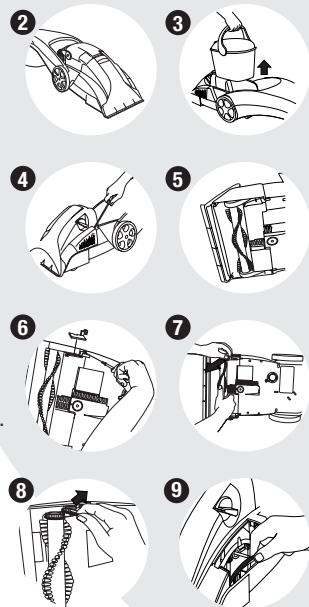

WARNING:
To reduce the risk of fire, electric shock or injury unplug from outlet before servicing.

To Install The Replacement Pump Belt

1. With the unit still on its side, loop one end of the replacement Pump Belt around the Red Pump Pulley and then the other end around the silver motor shaft. Do not twist the replacement pump belt.
2. Re-install the "toothed" Brush Belt first onto the Red Pump Pulley and then onto the toothed end of the Brush.
3. Re-install the brush into the base of the unit.
4. Place the black brush arm onto the Brush and slide black brush arm into original position.
5. Re-install the Red Retainer Plate and Phillips head screw.
6. Using your finger, gently spin the replacement pump belt on the silver motor shaft. If assembled correctly, the replacement Pump Belt should rotate freely around the silver motor shaft and drive pulley without obstruction. The brush should also rotate freely when the silver motor shaft is turned.
7. Turn the machine right side up and replace the Tank-in-Tank and belt access door.
8. Assembly is now complete.
If you have any questions, or are having trouble installing your replacement pump belt, please call BISSELL Consumer Services at 1-800-237-7691.

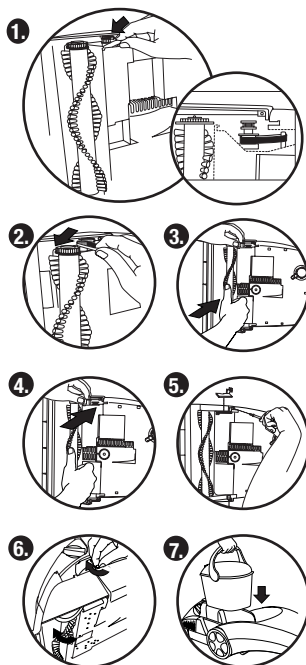



WARNING:

To reduce the risk of fire, electric shock or injury, unplug appliance from outlet before servicing.

Reduced Spray Or No Spray.

Possible Causes

- 1 Bladder may be empty.
- 2 The Lint Screen may be clogged.
- 3 Tank-in-Tank may not be seated properly.
- 4 Pump may have lost prime.
- 5 The Pump Belt may be broken.

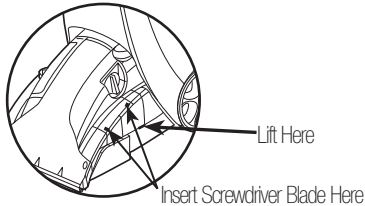

Remedies

- 1 Turn power OFF; refill tank with hot tap water.
- 2 Clean out Lint screen page 7.
- 3 Turn power OFF; remove tank and reseal tank.
- 4 Turn power OFF; after 1 minute, turn ON and depress Spray trigger.
- 5 Turn power OFF and unplug from the outlet. To check if a Pump Belt has broken, you will need a flat head screwdriver. Insert the blade end into the lower slot of the Belt Access door to release the lower snap. If necessary, insert the blade end into the upper slot to release the upper snap. Examine the belt for breakage. You should be able to see the Pump Belt looped around the motor shaft. If it is broken or missing, please refer to the part numbers and descriptions on page 15 before calling Consumer Services. Complete installation instructions will accompany the replacement belt.

DirtLifter PowerBrush Does Not Turn.

Possible Causes

- 1 The Brush Belt or Pump Belt may be broken.

Remedies

- 1 Turn power OFF and unplug from the outlet. To check if a Brush Belt has broken, you will need a flat head screwdriver. Insert the blade end into the lower slot of the Belt Access door to release the lower snap. If necessary, insert the blade end into the upper slot to release the upper snap. Examine the belt for breakage. If broken, refer to pages 11-12.

PowerSteamer is not picking up solution and water.

Possible Causes

- 1 ReadyTools Dial may be at the wrong setting for cleaning job.
- 2 Nozzle Window may not be properly attached.
- 3 Tank-in-Tank Lid is not properly installed.
- 4 Tank-in-Tank is not properly seated.
- 5 Poor tool position.
(Handheld attachments only)
- 6 Tank-in-Tank has picked up the maximum dirty water.

Remedies

- 1 Set ReadyTools Dial to either FLOOR CLEANING or TOOLS/PRETREAT.
- 2 Make sure the two tabs on the back of the Floor Nozzle Window are inserted through the mating slots in the main housing. Reinstall if necessary.
- 3 Reinstall lid; refer to The Basics section, page 6.
- 4 Tank-in-Tank must be firmly seated to function. Remove and reseal Tank-in-Tank.
- 5 Readjust angle; apply more downward pressure.
- 6 Empty tank and refill; refer to The Basics section, page 6.

Thank you for selecting a BISSELL product.

If you should happen to need assistance during assembly or operations, call 1-800-237-7691.

Please do not return this product to the store

BISSELL Consumer Services

For information about repairs or replacement parts, or questions about your warranty, call:

BISSELL Consumer Services

1-800-237-7691

Monday - Friday

8 a.m. — 10 p.m. ET

Saturday

9 a.m. — 8 p.m. ET

Or write:

BISSELL HOMECARE, INC

PO Box 3606

Grand Rapids MI 49501

ATTN: Consumer Services

Or visit the BISSELL website - www.bissell.com

When contacting BISSELL, have model number of unit available.

Please record your Model Number: _____

Please record your Purchase Date: _____

Replacement Parts

***Not all parts included with every model**

Item	Part No.	Part Name
1	214-4025	Handle Assembly with Screw
2	215-9155	Tough Stain Brush
3	015-9043	Tank Assembly Complete
4	015-4439	Tank Lid Assembly
5	015-9041	Tank Bottom
6	213-0213	Baffle with Red Float
7	210-4052	Window Gasket
8	215-0628	Replacement Pump Belt (with instructions)
9	015-0621	Replacement Brush Belt (with instructions)
10	015-3500	Lint Screen
11	213-3010	Measuring Cup
12	214-9131	Bare Floor Tool
13	0710	48 oz. BISSELL Fiber Cleansing Formula with Scotchgard™ Protector
14	0400	22 oz. BISSELL Tough Stain PreCleaner
15	0484	32 oz. BISSELL Hard Floor Solutions™

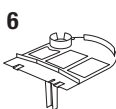

About Your Warranty

This warranty gives you specific legal rights, and you may also have other rights which may vary from state to state. If you need additional instruction regarding this warranty or have questions regarding what it may cover, please contact BISSELL Consumer Services by E-mail, telephone, or regular mail as described below.

Limited **One** Year Warranty

Subject to the *EXCEPTIONS AND EXCLUSIONS identified below, upon receipt of the product BISSELL Homecare, Inc. will repair or replace (with new or remanufactured components or products), at BISSELL's option, free of charge from the date of purchase by the original purchaser, for one year any defective or malfunctioning part.

See information below on "If your BISSELL product should require service".

This warranty applies to product used for personal, and not commercial or rental service. This warranty does not apply to fans or routine maintenance components such as filters, belts, or brushes. Damage or malfunction caused by negligence, abuse, neglect, unauthorized repair, or any other use not in accordance with the User's Guide is not covered.

If your BISSELL product should require service:

Contact BISSELL Consumer Services to locate a BISSELL Authorized Service Center in your area.

If you need information about repairs or replacement parts, or if you have questions about your warranty, contact BISSELL Consumer Services.

Website or E-mail:

www.bissell.com

Use the "Customer Services" tab.

Or Call:

BISSELL Consumer Services

1-800-237-7691

Monday - Friday 8 am. - 10 pm. ET

Saturday 9 am. - 8 pm. ET

Or write:

BISSELL Homecare, Inc.

PO Box 3606

Grand Rapids, MI 49501

ATTN: Consumer Services

BISSELL HOMECARE, INC. IS NOT LIABLE FOR INCIDENTAL OR CONSEQUENTIAL DAMAGES OF ANY NATURE ASSOCIATED WITH THE USE OF THIS PRODUCT. BISSELL'S LIABILITY WILL NOT EXCEED THE PURCHASE PRICE OF THE PRODUCT.

Some states do not allow the exclusion or limitation of incidental or consequential damages, so the above limitation or exclusion may not apply to you.

*EXCEPTIONS AND EXCLUSIONS FROM THE TERMS OF THE **LIMITED** WARRANTY

THIS WARRANTY IS EXCLUSIVE AND IN LIEU OF ANY OTHER WARRANTIES EITHER ORAL OR WRITTEN. ANY IMPLIED WARRANTIES WHICH MAY ARISE BY OPERATION OF LAW, INCLUDING THE IMPLIED WARRANTIES OF MERCHANTABILITY AND FITNESS FOR A PARTICULAR PURPOSE, ARE LIMITED TO THE ONE YEAR DURATION FROM THE DATE OF PURCHASE AS DESCRIBED ABOVE.

Some states do not allow limitations on how long an implied warranty lasts, so the above limitation may not apply to you.

NOTE: Please keep your original sales receipt. It provides proof of date of purchase in the event of a warranty claim.



©2008 BISSELL Homecare, Inc.
Grand Rapids, Michigan
All rights reserved.
Part Number 310-5907
Rev 6/08
Visit our website at:
www.bissell.com
Scotchgard is a trademark of 3M.