

SPOTBOT[®] PET

Portable Deep Cleaner

USER GUIDE
33N8 SERIES

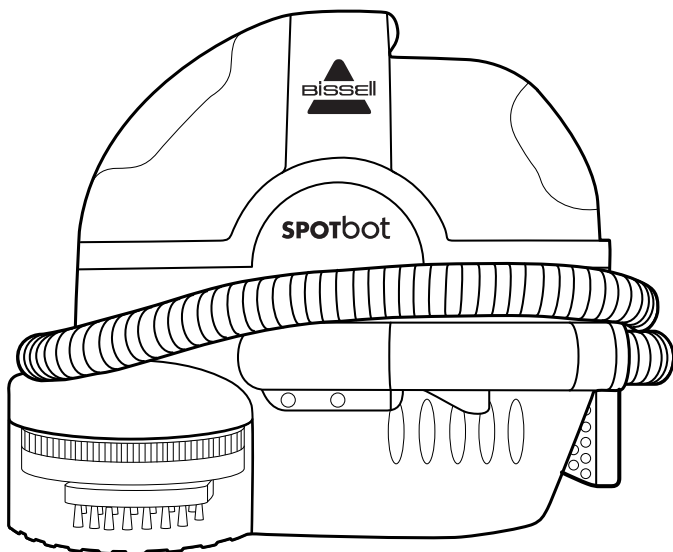

IMPORTANT SAFETY INSTRUCTIONS

READ ALL INSTRUCTIONS BEFORE USING YOUR PORTABLE DEEP CLEANER.

When using an electrical appliance, basic precautions should be observed, including the following:

⚠️ WARNING

TO REDUCE THE RISK OF FIRE, ELECTRIC SHOCK, OR INJURY:

- » Use only BISSELL cleaning products intended for use in this machine to prevent internal component damage. See the Cleaning fluid section of this guide.
- » Connect to a properly grounded outlet only. See grounding instructions. Do not modify the 3-prong grounded plug.
- » Unplug from outlet when not in use and before servicing.
- » Do not expose to rain. Store indoors.
- » Do not allow to be used as a toy. Close attention is necessary when used by or near children.
- » Do not use for any purpose other than described in this User's Guide. Use only manufacturer's recommended attachments.

- » Do not use with damaged cord or plug. If appliance is not working as it should, has been dropped, damaged, left outdoors, or dropped into water, have it repaired at an authorized service center.
- » Do not pull or carry by cord, use cord as a handle, close a door on cord, or pull cord around sharp edges or corners. Do not run appliance over cord. Keep cord away from heated surfaces.
- » Do not unplug by pulling on cord. To unplug, grasp the plug, not the cord.
- » Do not handle plug or appliance with wet hands.
- » Do not put any object into openings. Do not use with any opening blocked; keep openings free of dust, lint, hair, and anything that may reduce air flow.
- » Keep hair, loose clothing, fingers, and all parts of body away from openings and moving parts.
- » Turn off all controls before plugging or unplugging appliance.
- » Use extra care when cleaning on stairs.
- » Do not use to pick up flammable or combustible materials (lighter fluid, gasoline, kerosene, etc.) or use in areas where they may be present.
- » Do not use appliance in an enclosed space filled with vapors given off by oil base paint, paint thinner, some moth proofing substances, flammable dust, or other explosive or toxic vapors.
- » Do not use to pick up toxic material (chlorine bleach, ammonia, drain cleaner, etc.).
- » Do not pick up anything that is burning or smoking, such as cigarettes, matches, or hot ashes.
- » Keep appliance on a level surface.
- » Do not carry the appliance while in use.

SAVE THESE INSTRUCTIONS FOR FUTURE USE

This model is for household use only. Commercial use of this unit voids the manufacturer's warranty.

⚠️ WARNING

Improper connection of the equipment-grounding conductor can result in a risk of electrical shock. Check with a qualified electrician or service person if you aren't sure if the outlet is properly grounded. **DO NOT MODIFY THE PLUG.** If it will not fit the outlet, have a proper outlet installed by a qualified electrician. This appliance is designed for use on a nominal 120-volt circuit, and has a grounding attachment plug that looks like the plug in the illustration. Make certain that the appliance is connected to an outlet having the same configuration as the plug. No plug adapter should be used with this appliance.

GROUNDING INSTRUCTIONS

This appliance must be connected to a grounded wiring system. If it should malfunction or break down, grounding provides a safe path of least resistance for electrical current, reducing the risk of electrical shock. The cord for this appliance has an equipment-grounding conductor and a grounding plug. It must only be plugged into an outlet that is properly installed and grounded in accordance with all local codes and ordinances.

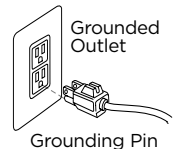

Thanks for buying a BISSELL carpet cleaner!

We love to clean and we're excited to share one of our innovative products with you. We want to make sure your carpet cleaner works as well in two years as it does today, so this guide has tips on using (page 9), maintaining (page 13), and if there is a problem, troubleshooting (page 14).

In just a few simple preparation steps, you'll be ready to deep clean. Flip to page 7 and let's get started!

Package Contents

1.

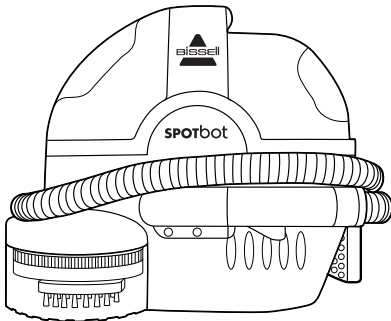

1. SpotBot® Unit
2. Tough Stain Tool
3. BISSELL Formula
4. BISSELL Boost Formula

2.

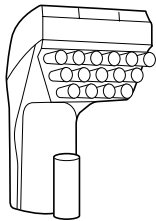

3.

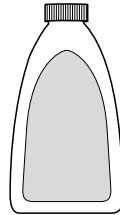

4.

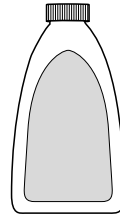

Safety Instructions.....	2	Troubleshooting	13
Product View.....	4	Warranty.....	15
Cleaning Formulas.....	6	Service.....	15
Filling the Tank	7	Contact Information	15
Operations	8-11	Product Registration.....	16
Maintenance & Care	12	Parts & Supplies	16

Getting to Know Your Deep Cleaner

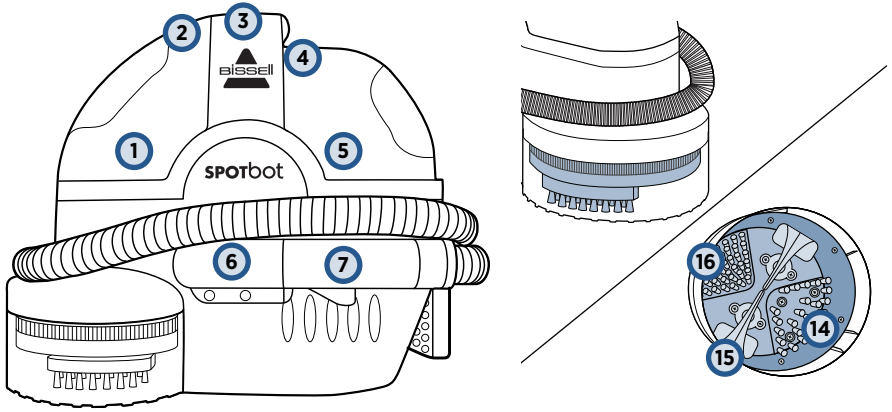

- 1 Dirty Water/Collection Tank
- 2 Tank Release Latch
- 3 Carry Handle
- 4 Automatic Smart System Control Panel
- 5 Clean Water/Solution Tank
- 6 Hose Connector
- 7 Spray Trigger
- 8 Cord Wraps
- 9 Power Cord
- 10 Vacuum Flex Hose
- 11 Tough Stain Brush
- 12 Tough Stain Brush Storage
- 13 Cleaning Window
- 14 Scrubbing Brushes
- 15 Suction Nozzles
- 16 Deep Reach Technology

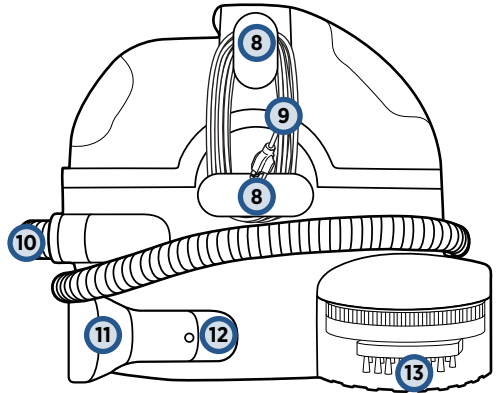

WARNING

Do not plug in your deep cleaner until you are familiar with all instructions and operating procedures.

Special Features

Front view

4 - Preset Cleaning Cycles control panel

Located on top of the unit, you will find the control panel. Select the cleaning cycle you would like to use (detailed instructions on page 9). The "Power" and "Done" are not buttons; "Power" is an indicator light to tell you when the SpotBot® is "on". "Done" is an indicator light to tell you when the cleaning cycle is done.

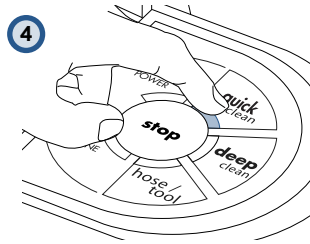

7 - Spray trigger

Press the spray trigger to release water and formula onto the area to be cleaned. (Only use in hose/tool mode)

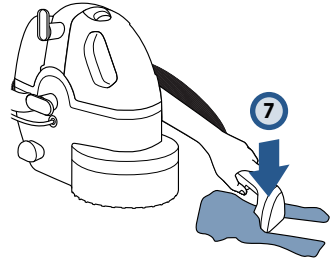

10 - Vacuum flex hose

Wraps around the center of the unit, and serves as the travel path for dirty water and formula suctioned into the dirty water/collection tank. The hose can also be unwrapped and used with the tough stain tool for manual cleaning in hose/tool mode.

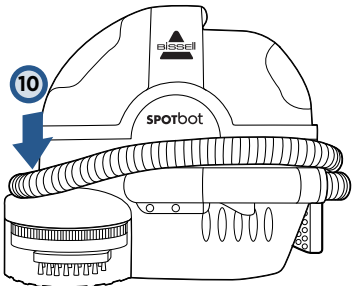

Back view

12 - Tough Stain Brush Storage

Stored on board for your convenience.

13 - Cleaning window

Provides an area to see the hands-free cleaning action.

NOTE: Unwrap power cord completely before operating the unit.

Underside view

14 - Scrubbing Brushes

Automatically spray, brush and remove both surface and tough stains and odors.

15 - Suction nozzles

Provides suction path when using the handsfree cleaning cycles.

16 - Deep Reach Technology

Delivers solution further into the carpet where the deepest part of the stain resides. .

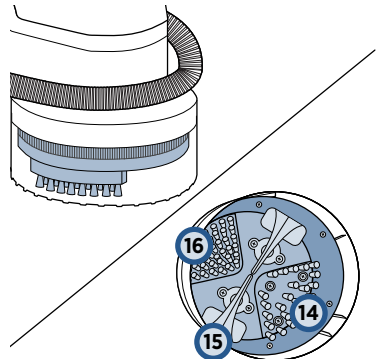
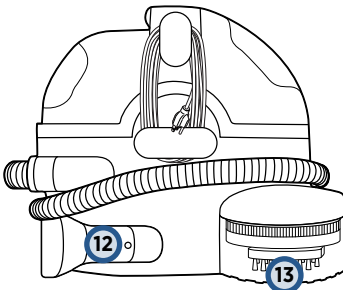

Cleaning Formulas

WARNING

To reduce the risk of fire and electric shock due to internal component damage, use only BISSELL cleaning fluids intended for use with the deep cleaner.

NOTICE: Use only BISSELL portable machine formulas (with Boost if desired) in your cleaner. Use of cleaning formulas which contain lemon, pine oil or vinegar may damage this appliance and void the warranty. Chemical spot cleaners or solvent-based soil removers also should not be used. These products may react with the plastic materials used in your cleaner, causing cracking or pitting.

Always use genuine BISSELL deep cleaning formulas. Non-BISSELL cleaning solutions may harm the machine and may void the warranty.

2X CLEANING FORMULA			BOOST CARPET CLEANING FORMULA ENHANCER		
					
Spot & Stain Formula	Pet Stain & Odor Formula	Spot & Stain with Febreze®	Oxy Boost	Prevent Boost	Pet Oxy Boost
Removes deep down dirt, pet stains, & pet odor	Removes tough pet stains and contains patented odor removal technology	Powerful cleaning with a refreshing scent	Removes old, set-in stains permanently	Repels stains from soaking into carpet fibers	Removes pet stains and odors permanently

Febreze is a trademark of The Proctor & Gamble Company, Cincinnati, Ohio used under license by BISSELL Homecare, Inc.

A note about BISSELL formula

One of the effective stain removing ingredients in Oxy Boost and Pet Oxy Boost is Hydrogen Peroxide. Certain people may be affected by the product when it comes into contact with their skin; it may turn the skin white and/or cause tingling. Washing your hands after use and applying hand lotion will remove any possible white discoloration.

Filling Your Clean Water Tank: Portable Machine Formula (2X Concentrated)

1

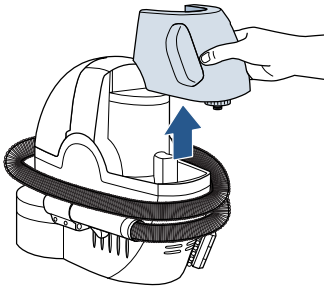

To fill the clean water/solution tank, remove the clean water tank by lifting it straight up and then away from the unit.

2

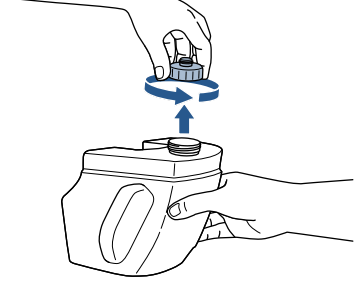

Unscrew the black cap at the bottom of the clean water tank.

3

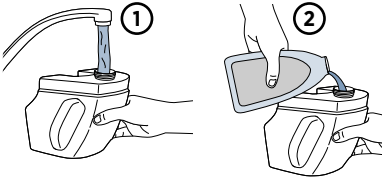

1) Add hot tap water to water fill line.
2) Add formula by following the indicated "formula" fill line on your clean tank

4

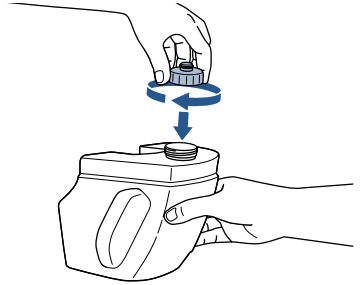

Twist the cap back into place and set tank back on unit.

A few notes about filling the clean water tank:

- Fill with hot (140°F/60°C MAX) tap water and add the appropriate BISSELL solution.
- Fill with formula to the fill line as indicated.

DO NOT USE BOILING WATER. DO NOT HEAT WATER OR TANK IN MICROWAVE.

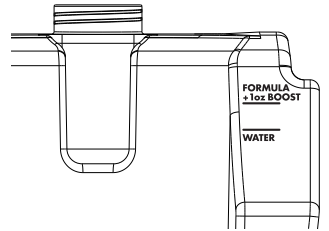

Pour in more power with BISSELL Boosts

- Fill tank with water and 2X formula (Step 3 above).
- Add 1 ounce of any BISSELL Boost.

Using the Automatic Cleaning Cycles

Tips Before Using Your SpotBot®

- Dry vacuum the area first, before spot cleaning with the SpotBot®.
- Some spots and spills require that you pick up the chunky debris with a rag or towel before you begin cleaning in the automatic or manual cycles.

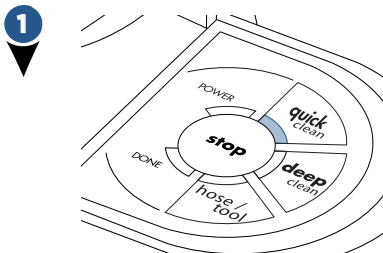

Quick Clean This cycle has been designed for stains that are on the surface of your carpeting. This cycle will run for approximately 3 minutes.

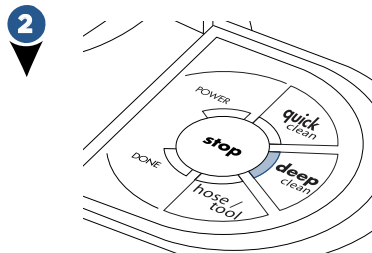

Deep Clean Use on stains that have had time to set-in. These are typically the most difficult stain types to remove. This cycle runs for approximately 6 minutes.

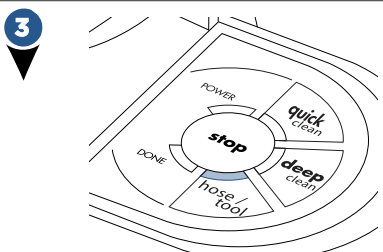

Hose/Tool By selecting this option you can clean spots and stains using the hose and tool on surfaces such as upholstery, stairs, car interiors or any other hard to reach area.

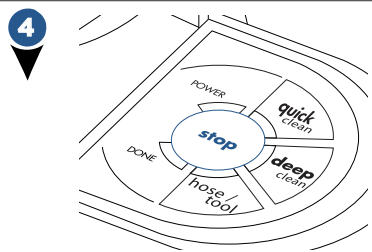

Stop By pressing the red stop button, you will stop the cleaning cycle completely. To begin cleaning again, you will need to start over and select a cleaning cycle.

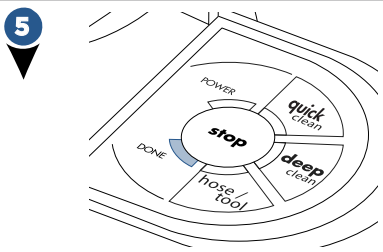

Done This light will illuminate and you will hear a series of “beeps” when the cleaning cycle is complete. Press the STOP button to turn the machine off. The machine will not beep when turned off.

WARNING

Keep spray away from face. Failure to do so may result in personal injury.

Getting Started

Important! Please check manufacturer's tag before cleaning area rugs for any specialized cleaning instructions. Not for use on silk or delicate area rugs.

1 Before using, test a small inconspicuous area for colorfastness.

2 Select "Hose/Tool" and follow manual cleaning instructions on page 10 to test.

Hands-Free Cleaning

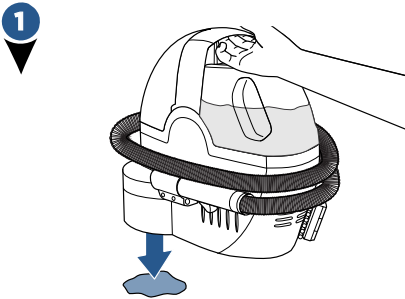

Place the unit directly over the spot or stain, making sure the stain is in the center of the cleaning area.

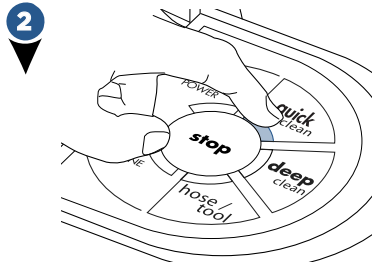

Select which cleaning cycle (**Quick Clean** or **Deep Clean**) you would like to use. SpotBot® will begin spraying, brushing and suctioning the soiled area, in a pre-programmed cycle.

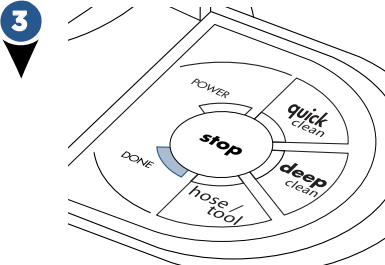

When the cleaning cycle you have selected is complete, the Done light will illuminate and the machine will sound a series of "beeps". Press the **STOP** button to turn the machine off. The machine will not beep when turned off.

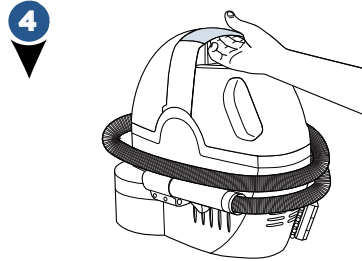

Pick up the unit and check the area that was cleaned.

If you use BISSELL Oxy Boost, it will continue to work for the next six to eight hours, cleaning your spots and stains all the way to the backing of the carpet.

NOTICE: To prevent damage to Berber carpets, avoid repeated cleaning cycles in the same area.

Manual Cleaning

- Check upholstery stuffing before cleaning. Colored stuffing may bleed through the fabric when it becomes wet. Check manufacturer's tag before cleaning.

1

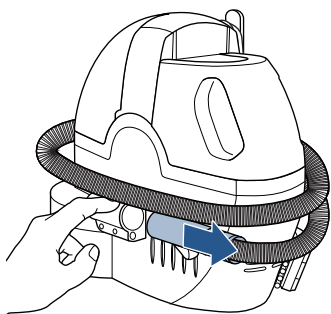

Remove the hose from the unit by depressing the release button and pulling outward on end of hose..

2

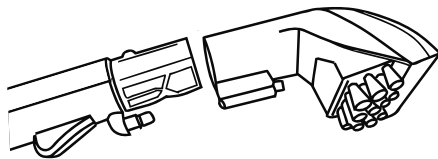

Remove the Tough Stain Brush from the back of the unit, then attach it onto the grip of the hose.

3

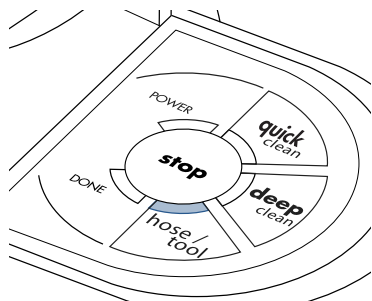

Select the **Hose/Tool** button on the control panel to start the SpotBot®.

4

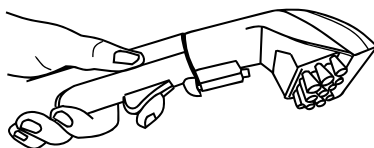

Press the spray trigger button to spray the soiled area, then slowly move tool back and forth over the area.

Release the trigger to suck up the dirty solution. Work in small sections until the area is clean.

5

If the stain is still visible, repeat step 4 as necessary.

NOTE: In manual mode, the SpotBot® is equipped with a safety feature which will shut the unit off after 30 minutes.

Manual Cleaning

6

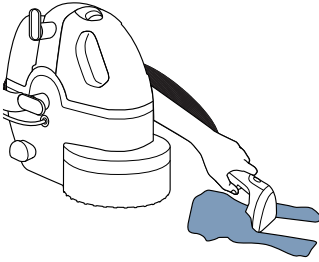

When the cleaning is complete, lightly drag the suction nozzle across the stain without pressing the trigger. This will help dry the cleaned area.

7

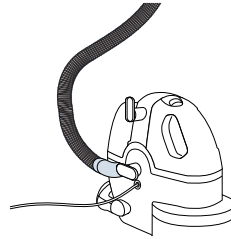

Before turning off the SpotBot®, suction up clean water to thoroughly rinse out the inside of the vacuum flex hose. Then, lift the vacuum flex hose upwards to drain any remaining water into the dirty tank.

8

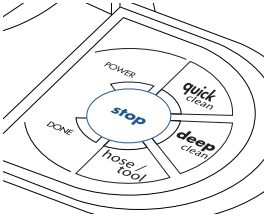

Press the **STOP** button to turn off the machine, then disconnect the cleaning tool from the vacuum flex hose by pushing down on the button lock and pulling straight off (do not twist tools to remove them).

9

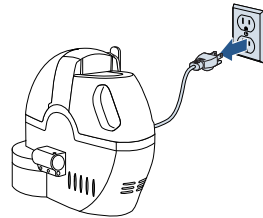

Unplug the machine and wrap the cord around the cord wraps. Attach the Tough Stain Brush to the base of machine. Wrap the hose around the machine and secure into the hose connector.

Tips While Cleaning

- Periodically clean out the black valve inside of the dirty water/collection tank.

Maintenance and Care

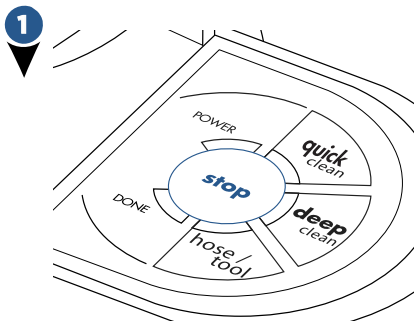

Press the **STOP** button to turn the unit off. Unplug the power cord from the outlet. Wrap power cord around the cord wrap.

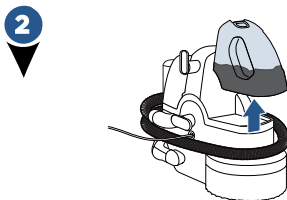

Empty and rinse the dirty water/collection tank after each use. To remove the tank, lift up the dirty tank latch and pull the tank out. Dump out the dirty water and rinse. Replace the tank into the unit for storage. After using the SpotBot's automated feature, wipe the window and brushing area with a soft cloth.

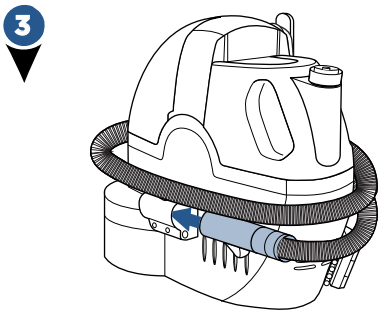

If you were using your SpotBot® manually, wrap the vacuum flex hose around the unit and secure the hose into the hose connector on the front of the unit.

Tips for Storing

- If a significant amount of water and solution remains in the clean tank, your unit can be stored with liquid in the clean tank. However, if you have added Oxy Boost into the clean tank, it cannot be stored in the unit and should be emptied and rinsed.
- Keep your machine clean and clean out the black valve periodically inside of the dirty water/collection tank.
- Store machine in a protected, dry area.

NOTICE: To reduce the risk of a leaking condition, do not store unit where freezing may occur. Damage to internal components may result.

Troubleshooting

WARNING

To reduce the risk of electric shock, turn power switch off and disconnect plug from electrical outlet before performing maintenance or troubleshooting checks.

Problem	Possible causes	Remedies
AUTOMATED CLEANING		
SpotBot® will not run	Power cord not plugged in	Check electrical plug
	Blown fuse/tripped breaker	Replace household fuse or reset breaker
	Vacuum flex hose is not snapped into place securely	Check to make sure the vacuum flex hose is snapped into place
Unusual or odd noise	Clean water/solution tank is out of fluid	Fill clean water/solution tank
Reduced or no spray	Clean water/solution tank is out of fluid	Fill clean water/solution tank
	Clean water/solution tank is not inserted into the unit securely	Gently press the clean water/solution tank until you see "bubbles" coming from the base of the tank
No suction	Tank is full	Empty tank
	Dirty water/collection tank latch is not down	Push latch down, securely into place
	Black valve on the dirty water/collection tank is missing	Replace black valve into dirty water/collection tank
MANUAL CLEANING		
Cleaner will not run	Power cord not plugged in	Check electrical plug
	Blown fuse/tripped breaker	Replace household fuse or reset breaker
	Hose not removed from receiver	Remove hose
	SpotBot® shut off automatically during use	Press Pause/Resume button to resume manual cleaning
Unusual or odd noise	Clean water/solution tank is out of fluid	Fill clean water/solution tank
Reduced or no spray	Spray tip clogged on Tough Stain brush	Clean spray tip
	Clean water/solution tank is out of fluid	Fill clean water/solution tank
	Clean water/solution tank is not inserted into the unit securely	Gently press the clean water/solution tank until you see "bubbles" coming from the base of the tank
No suction	Tank is full	Empty tank
	Dirty water/collection tank latch is not down	Push latch down, securely into place
	Black valve on the dirty water/collection tank is missing	Replace black valve into dirty water/collection tank

Notes

Warranty

This warranty gives you specific legal rights, and you may also have other rights which may vary from state to state. If you need additional instruction regarding this warranty or have questions regarding what it may cover, please contact BISSELL Consumer Care by E-mail, telephone, or regular mail as described below.

Limited Two-Year Warranty

Subject to the *EXCEPTIONS AND EXCLUSIONS identified below, upon receipt of the product BISSELL will repair or replace (with new or remanufactured components or products), at BISSELL's option, free of charge from the date of purchase by the original purchaser, for two years any defective or malfunctioning part.

See information below on "If your BISSELL product should require service".

This warranty applies to product used for personal, and not commercial or rental service. This warranty does not apply to fans or routine maintenance components such as filters, belts, or brushes. Damage or malfunction caused by negligence, abuse, neglect, unauthorized repair, or any other use not in accordance with the User's Guide is not covered.

BISSELL IS NOT LIABLE FOR INCIDENTAL OR CONSEQUENTIAL DAMAGES OF ANY NATURE ASSOCIATED WITH THE USE OF THIS PRODUCT. BISSELL'S LIABILITY WILL NOT EXCEED THE PURCHASE PRICE OF THE PRODUCT.

Some states do not allow the exclusion or limitation of incidental or consequential damages, so the above limitation or exclusion may not apply to you.

*EXCEPTIONS AND EXCLUSIONS FROM THE TERMS OF THE LIMITED WARRANTY

THIS WARRANTY IS EXCLUSIVE AND IN LIEU OF ANY OTHER WARRANTIES EITHER ORAL OR WRITTEN. ANY IMPLIED WARRANTIES WHICH MAY ARISE BY OPERATION OF LAW, INCLUDING THE IMPLIED WARRANTIES OF MERCHANTABILITY AND FITNESS FOR A PARTICULAR PURPOSE, ARE LIMITED TO THE TWO YEAR DURATION FROM THE DATE OF PURCHASE AS DESCRIBED ABOVE.

Some states do not allow limitations on how long an implied warranty lasts so the above limitation may not apply to you.

NOTE: Please keep your original sales receipt. It provides proof of date of purchase in the event of a warranty claim.

Service

If your BISSELL product should require service:

Contact BISSELL Consumer Care to locate a BISSELL Authorized Service Center in your area.

If you need information about repairs or replacement parts, or if you have questions about your warranty, contact BISSELL Consumer Care.

Website:

www.BISSELL.com/service-centers

E-mail:

www.BISSELL.com/email-us

Call:

BISSELL Consumer Care
1-800-237-7691
Monday - Friday 8am - 10pm ET
Saturday 9am - 8pm ET
Sunday 10am - 7pm ET

Please do not return this product to the store.

Other maintenance or service not included in the manual should be performed by an authorized service representative.

For any questions or concerns, BISSELL is happy to be of service. Contact us directly at 1-800-237-7691.

Register your product today!

Registering is quick, easy and offers you benefits over the lifetime of your product.

You'll receive:

BISSELL Rewards Points

Automatically earn points for discounts and free shipping on future purchases.

Faster Service

Supplying your information now saves you time should you need to contact us with questions regarding your product.

Product Support Reminders and Alerts

We'll contact you with any important product maintenance reminders and alerts.

Special Promotions

Optional: Register your email to receive notice of offers, contests, cleaning tips and more!

Visit www.BISSELL.com/registration!

Visit us online at: **BISSELL.com**

When contacting BISSELL, have model number of cleaner available.

Please record your

Model Number: _____

Please record your

Purchase Date: _____

NOTE: Please keep your original sales receipt. It provides proof of purchase date in the event of a warranty claim. See Warranty page for details.

Parts & Supplies

For Parts and Supplies, go to **BISSELL.com** and enter your model number in the search field.

We can't wait to hear from you!

We really do read your comments, tweets, and posts.

Rate this product on BISSELL.com

or any of our retailer sites and let us (and millions of your closest friends) know what you think!

For cleaning tips and more visit www.BISSELL.com or find us at:



BISSELL



BISSELLClean



BISSELLClean



BISSELL



BISSELL



©2017 BISSELL Homecare, Inc
Grand Rapids, Michigan
All rights reserved. Printed in China
Part Number 161-2470 4/17 RevA
Visit our website at: www.BISSELL.com
Scotchgard is a trademark of 3M