

**Heavy Duty
Upright
Vacuum Cleaner**
Household Type
Owner's Guide
600 Series

Index

Important Safeguards	2
Service Information	4
Assemble	5
Use	7
Dust Bag	8
Brush Roll Belt	9
Brush Roll	10
Headlight	11

For location of nearest Eureka/
Sanitaire Warranty Station or service
information call 1-800-282-2886.

www.eureka.com

IMPORTANT SAFEGUARDS

When using an electrical appliance, basic precautions should always be followed, including the following:

READ ALL INSTRUCTIONS BEFORE USING THIS VACUUM CLEANER.

WARNING

To reduce the risk of fire, electric shock, or injury:

- Do not use outdoors or on wet surfaces.
- **Do not leave vacuum cleaner when plugged in.** Turn off the switch and unplug the electrical cord when not in use and before servicing.
- Do not allow to be used as a toy. Close attention is necessary when used by or near children.
- Use only as described in this manual. Use only manufacturer's recommended attachments.
- Do not use with damaged cord or plug. If vacuum cleaner is not working as it should, has been dropped, damaged, left outdoors, or dropped into water, return it to a service center before using.
- Do not pull or carry by cord, use cord as a handle, close door on cord, or pull cord around sharp edges or corners. Do not run vacuum cleaner over cord. Keep cord away from heated surfaces.
- Do not use extension cords or outlets with inadequate current carrying capacity.
- Turn off all controls before unplugging.
- Do not unplug by pulling on cord. To unplug, grasp the plug, not the cord.
- Do not handle plug or vacuum cleaner with wet hands.
- Do not put any object into openings. Do not use with any opening blocked; keep free of dust, lint, hair, and anything that may reduce airflow.
- This vacuum cleaner creates suction and contains a revolving brush roll. Keep hair, loose clothing, fingers, and all parts of body away from openings and moving parts.
- Do not pick up anything that is burning or smoking, such as cigarettes, matches, or hot ashes.
- Do not use without dust bag in place.
- Belt pulleys can become hot during normal use. To prevent burns, avoid touching the belt pulley when servicing the drive belt.
- Use extra care when cleaning on stairs.
- Do not use to pick up flammable or combustible liquids such as gasoline, or use in areas where they may be present.
- Store your cleaner indoors in a cool, dry area.
- Keep your work area well lighted.
- Unplug electrical appliances before vacuuming them.

SAVE THESE INSTRUCTIONS

CONSEILS DE SÉCURITÉ

Lors de l'utilisation d'un appareil électrique, quelques précautions élémentaires doivent être observées, incluant les suivantes:

LISEZ TOUTES LES INSTRUCTIONS AVANT D'UTILISER VOTRE ASPIRATEUR.

AVERTISSEMENT

Pour réduire le risque de feu, de choc électrique, ou de blessure:

- Ne pas utiliser à l'extérieur ou sur des surfaces mouillées.
- **Fermez le commutateur et débranchez l'appareil lorsque vous ne l'utilisez pas ou avant le nettoyage ou l'entretien.**
- Ne permettez pas qu'il soit utilisé comme jouet. Une attention particulière est nécessaire lorsque utilisé par ou près d'un enfant.
- Suivez les recommandations d'utilisation de ce manuel. Utilisez uniquement les accessoires recommandés par le fabricant.
- Ne pas utiliser si le cordon ou la fiche sont endommagés. Si l'aspirateur ne fonctionne pas comme il le devrait, s'il a été échappé, s'il est endommagé, s'il a été laissé à l'extérieur ou échappé dans l'eau, retournez-le à un centre de service avant de utiliser.
- Ne pas le tirer ou le transporter par le cordon, ne pas utiliser le cordon en guise de poignée. Ne pas fermer une porte sur le cordon ou tirer le cordon sur des coins ou bordures pointus. Ne pas circuler sur le cordon avec l'aspirateur. Tenir le cordon à distance des surfaces chauffantes.
- Ne pas utiliser des rallonges ou des prises qui n'ont pas de capacité suffisante pour transporter le courant.
- Fermer tous les contrôles avant débrancher.
- Ne pas débrancher en tirant sur le cordon. Pour débrancher, tenez la fiche et non le cordon.
- Ne pas manipuler la fiche ou l'aspirateur avec les mains mouillées.
- Ne pas rien insérer dans les ouvertures. Ne pas utiliser si des ouvertures sont bloquées; assurez-vous qu'elles soient dégagées de poussière, mousse, cheveux ou toute autre chose qui pourrait réduire le passage de l'air.
- Cet aspirateur crée de la succion et contient un rouleau-brosse tournant. Tenir les parties mobiles et les ouvertures loin des cheveux, du linge, des doigts et de toute partie du corps.
- Ne pas ramasser des objets qui brûlent ou fument comme les cigarettes, allumette ou cendres chaudes.
- N'utilisez pas sans le sac de poussière en place.
- Les poulies du courroie peuvent devenir chaudes pendant l'utilisation normale. Pour prévenir des brûlures, évitez de touché la poulie du courroie lorsque vous réparez la courroie.
- Portez une attention particulière lorsque vous nettoyez les escaliers.
- Ne pas utiliser pour ramasser des liquides inflammables ou combustibles comme de l'essence: Ne pas utiliser dans les endroits où ces liquides pourraient être présents.
- Entreposez votre aspirateur à l'intérieur dans un endroit propre et sec.
- Maintenez un bon éclairage à l'endroit où vous travaillez.
- Débrancher les appareils électriques avant de les balayer.

CONSERVEZ CES INSTRUCTIONS

To reduce the risk of electric shock, this appliance has a polarized plug (one blade is wider than the other). This plug will fit in a polarized outlet only one way. If the plug does not fit fully in the outlet, reverse the plug. If it still does not fit, contact a qualified electrician to install the proper outlet. Do not change the plug in any way.

Afin de réduire le risque de choc électrique, cet appareil est muni d'une fiche polarisée (une des lames est plus large). Cette fiche ne peut être insérée dans une prise polarisée que d'une seule façon. Si la fiche ne peut être insérée dans la prise, retourner la fiche. Si la fiche ne peut toujours pas être insérée dans la prise, faire installer une prise adéquate par un électricien qualifié. Ne pas modifier la fiche.

GENERAL INFORMATION

The cleaner is designed to pick up dirt and dust particles. Avoid picking up hard or sharp objects with the cleaner to prevent bag tears, hose clogs, and fan blade breakage with subsequent motor damage.

Service Information

The instructions in this booklet serve as a guide to routine maintenance. For additional service information telephone our toll free number for the nearest Eureka/Sanitaire Authorized Warranty Station. **You should know the model, type and serial numbers when you call:**

USA: 1-800-282-2886
Mexico: 5670-6169
Canada: 1-800-282-2886

If you prefer, you can write to The Eureka Company, Service Division, 807 North Main Street, Bloomington, Illinois 61701, USA. In Canada write to The Eureka Company, 866 Langs Drive, Cambridge, Ontario N3H 2N7. Refer to The Sanitaire Limited Warranty for complete service information.



DO NOT OIL the motor or the brush roll at any time. The bearings are permanently lubricated and sealed.

Rating Plate

The model, type, and serial numbers are indicated on the rating plate located on the underneath side of the cleaner. For prompt and complete service information, always refer to these numbers when inquiring about service.

MODEL	TYPE	SERIAL NO.
VOLTS	AMPS.	HERTZ
SERVICE INFORMATION: 1-800-282-2886		

Model & Type_____

Serial No._____

HOW TO ASSEMBLE

CAUTION: Completely assemble vacuum cleaner before using.

**Assembly Packet
is with owner's guide.**

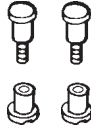

A
2-Part
Bolt



B
Upper
Cord Hook



C
Lower
Cord Hook



D
Bag
Screws

Step 1 Attach the Handle

Push the handle sections together. Note: Check to be sure slots in handle are correct, see Detail A.

Align the holes in the handle. Insert a 2-part bolt (A) in the center of the handle and tighten.

Push handle into the handle socket so handle grip curves away from the cleaner. Align the holes, insert the other 2-part bolt (A) and tighten.

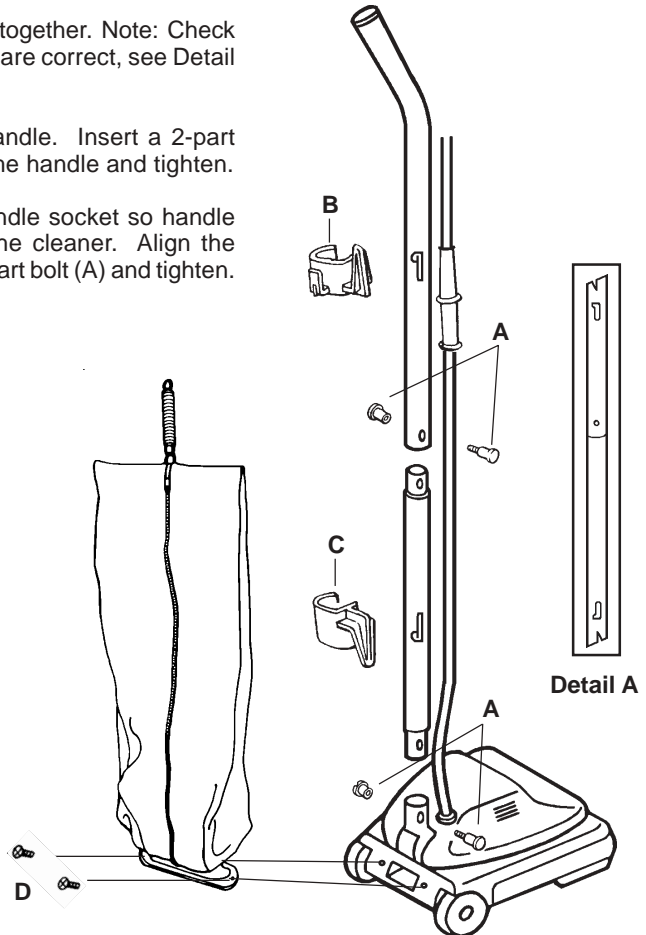

Step 2

Attach Upper Cord Hook

Pull the flexible cord support up toward the top of the handle.

Insert the lower half of the cord support into the upper cord hook.

Check to be sure slots in handle are correct, see Detail A. Place inner tab of cord hook into handle slot as shown (1) and press hook handle (2) SNAPPING opposite inner tab into place (3).

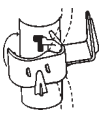
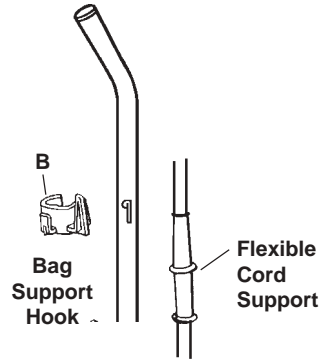

1. Place inner tab into slot

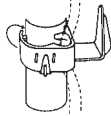

2. Press hook around handle

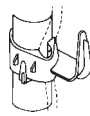

3. SNAP opposite inner tab into place

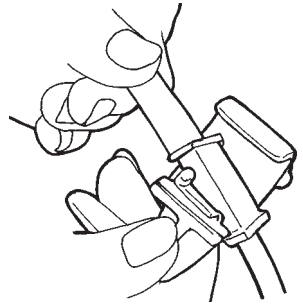

Upper Cord Hook

Step 3

Attach Lower Cord Hook

Insert the power cord into the lower cord hook. Snap the hook into the lower handle.

Pull up on the cord to tighten but leave enough slack near the base so there is no strain on the cord when the handle is lower.

Step 4

Store Electrical Cord

Wrap the cord around the two cord hooks. Fasten the plug to the electrical cord to prevent unwinding.

Step 5

Attach Outer Bag

Important: To provide a good gasket seal, the bag coupling must seat firmly against the motor base and not overlap the furniture guard.

Hold outer bag with zipper away from the handle. Start the bag screws (D) by hand, then tighten with a screwdriver.

Loop the bag spring onto the bag support hook on the back of the upper cord hook.

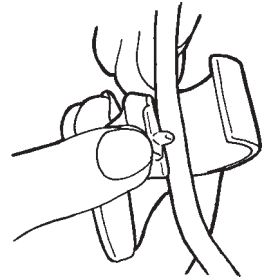

Lower Cord Hook

HOW TO USE

The upright vacuum cleaner is designed to be used on multiple types of carpeting. **Do not attempt to use the upright vacuum cleaner on bare floors**, as damage to the floor covering may result. Above the floor cleaning tools are available (optional).

Handle Adjustment

With the tip of the foot, press down to release the handle lock located at the left rear side of the cleaner. Move the handle and adjust it to the desired position for (1) storing upright, (2) operating the cleaner at a comfortable height for the user, and (3) cleaning underneath low furniture.

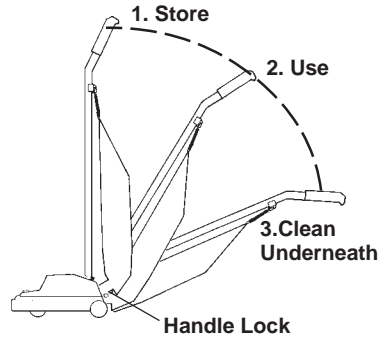

Power Switch

The power switch is mounted on the motor hood. A push with the foot turns the motor ON; push again to turn the motor OFF.

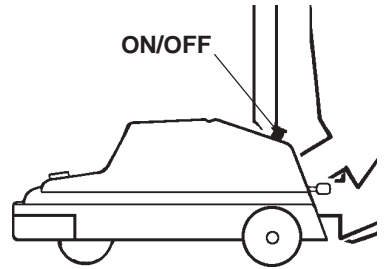

Cord Storage

The cleaner has two convenient cord storage hooks attached to the handle. However, some models feature a quick release cord hook on the upper handle. A downward twist of the cord hook frees the cord for quick removal. With either style, wind the cord around the hooks for storage. Fasten the plug to the cord to prevent unwinding.

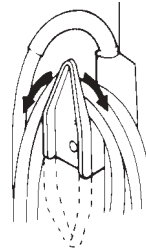

Cleaner Height Setting

WARNING: Avoid injury. Keep loose clothing, hair, fingers, and all other parts of body away from any moving part (such as the revolving brush). Turn off the switch and unplug the cleaner before changing the cleaner height setting.

The front of the cleaner has an adjustment that raises or lowers the cleaner base to match the type of carpet. With the cleaner cord unplugged, set the adjustment to lowest setting for maximum cleaning. If the cleaner is difficult to push, move adjustment to next highest setting until cleaner is comfortable to push. The brush roll must reach the carpet for effective cleaning.

Make each adjustment with cleaner switch off and cord disconnected from outlet. For ease in moving the adjustment knob, place handle in operating position and tilt cleaner back to remove weight from front wheels.

HOW TO MAINTAIN



The instructions given in this booklet serve as a guide to routine maintenance. To avoid unnecessary service calls, check the bag, belt and brush roll often.

Disposable Dust Bags

Paper bags play a very important role in the efficiency of a vacuum cleaner. The purpose of a paper bag is to trap dirt. But at the same time the paper bag must be porous enough to allow air to pass through. If the paper bag becomes clogged, no air can pass through the cleaner and no cleaning can take place, regardless of how powerful the unit. Change the dust bag frequently. Some fine particles can restrict airflow very quickly and will decrease performance even before the bag appears to be full. For that reason, when vacuuming carpet fresheners or cleaners, powder, plaster dust, or similar fine substances, the bag may need to be changed more often.

How To Change Disposable Dust Bag–Style F & G

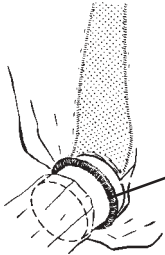
NOTE: Turn off the switch and unplug the electrical cord before changing dust bag. Never operate the vacuum cleaner without the dust bag.

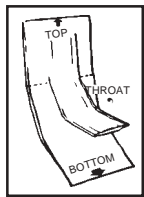
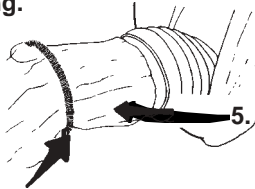
1. Pull zipper down.

2. Roll down coil spring.

3. Pull bag throat off sleeve.

4. Unfold new bag.

5. Place bag throat on sleeve.

6. Roll up coil spring.
7. Place paper bag into outer bag.
NOTE: Be certain there are no folds at the top or bottom of the paper bag.
8. Lift zipper.

Look for the  symbol.

Ask for **GENUINE EUREKA** dust bags–Style F & G.

Micron Filter® Bag Care (Micron Filter Bag is standard on some models)

Because the Micron Filter Bag is an effective filter medium, occasionally trapped dust particles will need to be cleaned from the inside of it. The dust accumulation can be vacuumed out with another vacuum or the bag may be removed to shake out. If you desire, the bag may be hand laundered. The zipper on the bag should be down and the bag should remain right side out. Use warm water (150°F 65°C) and a mild detergent. Pre-soaking the bag in a laundry pre-soak is desirable for best cleaning results. Air dry thoroughly before using.

DO NOT USE AN AUTOMATIC WASHER OR DRYER as either will cause abrasion to the delicate polyester fabric. **DO NOT DRY CLEAN** as dry cleaning fluids will damage plastic parts of your bag assembly.

Brush Roll Belt

The brush roll belt on the upright vacuum cleaner drives the brush to agitate, sweep, and comb the carpet nap. The belt should be checked regularly to be sure it is in good condition. Replace the belt if it is stretching, cracking, or slipping. Cut away any hair or thread wound around the brush roll or the belt pulley because the buildup could cause the belt to rotate unevenly.

How To Replace A Worn Belt

NOTE: Turn off the switch and unplug the electrical cord before replacing belt. Belt pulleys can become hot during normal use. To prevent burns, avoid touching the belt pulley when servicing the drive belt.

IMPORTANT: Improper installation of the brush roll or brush roll belt could cause carpet or cleaner damage.

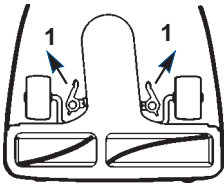

1. Release cam locks.

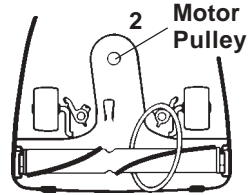

2. Pull up on belt to rotate it off the motor pulley. Lift up on brush roll and remove worn belt.

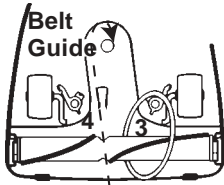

Check for brush wear (see Brush Roll instructions).

3. Place new belt around brush roll.
4. Align brush roll pulley with belt guide.

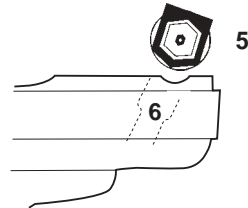

Metal Brush Roll only.

Place rubber end cap covers (available on select models) over both end caps (flat side against end cap). Align holes and secure.

5. Slant brush roll forward so end caps are in line with slots in cleaner base.
6. Push brush roll into base.

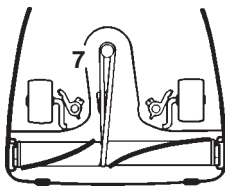

7. Place lower side of belt into belt guide and pull to stretch the belt around the left side of motor pulley. Rotate pulley to secure belt into groove.

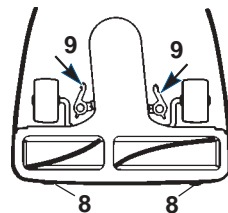

8. Place slots of bottom plate over tabs of cleaner base.
9. Seat and secure cam locks.

Ask for **GENUINE EUREKA** replacement belts, No. 52100



Look for the symbol.

Brush Roll

The rotating brush roll sweeps and combs the carpet nap. Keep the brush roll free from hair and threads so it will continue brushing. When the bristles of the brush roll no longer touch a straight edge held across the bottom plate, the brush roll is ineffective because the bristles no longer touch the carpet nap. To maintain the most effective cleaning, replace the worn brush roll. Install new brush strips on the chromed steel brush roll (refer to instructions).

How To Replace Worn Brush Strips (chromed steel brush roll)

NOTE: Turn off the switch and unplug the electrical cord before replacing brush strips.

New brush strips are supplied in sets of two, one long and one short. To replace, remove bottom plate and belt (see How To Change Belt). Then, grasp center of brush roll and lift to remove.

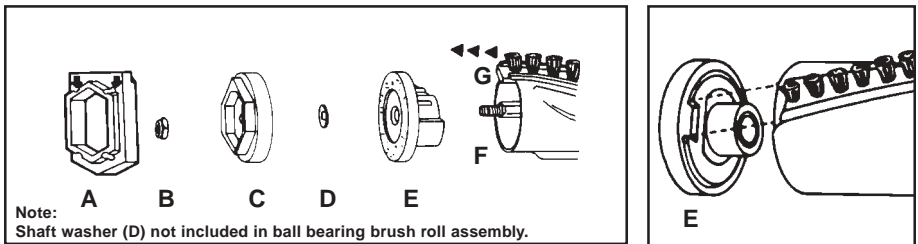

- A. Remove rubber end cap cover (available on select models) from one end.
- B. Unscrew locknut.
- C. Remove end cap.
- D. Remove shaft washer (*not included in ball bearing brush roll*).
- E. Remove bearing retainer.
- F. Push shaft through opposite end.
- G. Pull out worn brush strip with pliers.
- G. Slide in new brush strip of same length (rounded end first). Fit track on either side into brush roll slot. Replace second brush strip from opposite end of brush roll.
- F. Replace shaft.
- E. Align indentation on bearing retainer with brush strip on both ends of brush roll.
- D. Replace shaft washer.
- C. Position end cap with flat sides of center hole over flat sides of threaded shaft.
- B. Tighten locknut.
- A. Align holes and secure rubber end cap cover flat side against end cap.

When properly assembled, the brush roll should rotate freely between the two end caps. Check the condition of the belt; change if necessary. Replace the brush roll, belt, and bottom plate (see How To Replace A Worn Belt).

**Ask for GENUINE EUREKA replacement brush strip.
12 inch No. 52282.**

Headlight Bulb (Standard on most models)

NOTE: Turn off the switch and unplug the electrical cord before replacing headlight bulb.

Headlight style varies by model. Locate the notches that release the tabs at either (1) top, (2) side, or (3) bottom of the lens, as illustrated. Place a screwdriver into one notch; twist or pry the screwdriver to release the lens. Repeat for the second notch on the opposite side.

Rotate the bulb socket forward. Push bulb in and turn to remove. Secure new bulb into socket and rotate bulb socket backward.

Replace the lens tabs into the top or the bottom of the hood opening. Rotate lens to position and press down at each notch until the lens locks into position.

NOTE: Use 25 watt replacement bulb, only.

Ask for GENUINE EUREKA replacement bulb, 40009A.

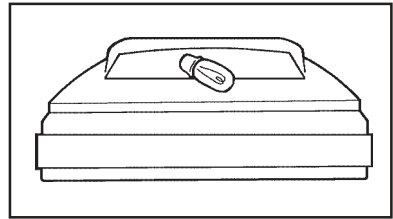
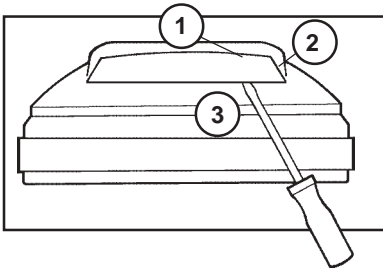

Cleaner Care

NOTE: Turn off the switch and unplug the electrical cord before cleaning unit.

To keep the vacuum cleaner looking new, it can be wiped with a damp cloth and a mild soap solution, then thoroughly dried. Never use any type of chemical as chemicals can damage the cleaner. When not in use, the cleaner should be stored in a clean, dry place.

